

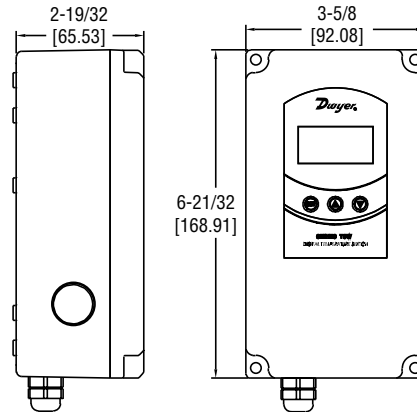

Series TSW Dual Stage Digital Temperature Switch

Specifications - Installation and Operating Instructions



The Series TSW Digital Temperature Switch combines the trusted, reliable TS family of temperature controls and an installation friendly weatherproof enclosure. By using the same programming parameters as our Series TS2 and Series TSS2, set up can be quickly completed using the front keys or by using the TS2-K configuration key. In order to prevent tampering from unauthorized users, a parameter lock physical jumper and software passcode security are standard in the unit. The bright, easy-to-read LED display shows the current output status and the temperature measurement.

The multiple conduit knockouts on the Series TSW give flexibility to the installer to determine the best location for the conduit entry. Another installation friendly feature of the Series TSW is the ability to quickly jumper the line voltage to the common of the output relay using fast tabs.

INSTALLATION

NOTICE: The thermostat must be installed by authorized professionals. It should be located in a place free of vibrators, impacts, and corrosive gases.

NOTICE: Protective plastic overlay should be peeled off after final installation.

SPECIFICATIONS

Probe Range:

PTC: -58 to 302°F (-50 to 150°C).

NTC: -58 to 230°F (-50 to 110°C).

Input: PTC (1000Ω @ 25°C)/NTC (10KΩ @ 25°C).

Output: R1 SPDT Relay Resistive Load: 20A @ 240 VAC; R2 SPDT Relay Resistive Load: 8A @ 240 VAC, Inductive Load: 3A @ 240 VAC.

Horsepower Rating: R1 2HP @ 240 VAC.

Control Type: On/Off.

Power Requirements: 90 to 255 VAC or 12 to 24 VAC/VDC (±10%) depending on model.

Power Consumption: 3.6VA.

Accuracy: ±1% FS.

Display: 3 digits plus sign.

Resolution: .1° < 100°; 1° ≥ 100°.

Memory Backup: Non-volatile memory.

Ambient Temperature: 32 to 104°F (0 to 40°C).

Weight: 1.2 lbs (544 g).

Front Protection: NEMA 4X (IP66).

Agency Approvals: CE, UL, cUL.



99 Washington Street
Melrose, MA 02176
Phone 781-665-1400
Toll Free 1-800-517-8431



WIRING INSTRUCTIONS

Wiring diagram is displayed on the inside cover of the unit and in figure 1.

NOTICE: If the length of the probe cables measures more than 100 meters, a recalibration adjustment must be made (parameter P1).

NOTICE: Avoid installing the probe cables in proximity with any power cables.

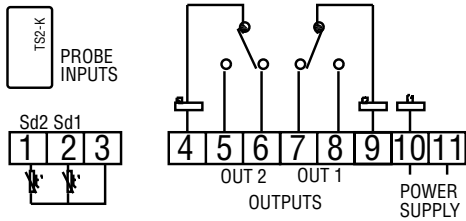

Figure 1

PROGRAMMING PARAMETERS

In order to adjust parameter values, parameter lock jumper must be set in unlocked position (see figure 2).



Figure 2

Access only to Set Points SP1 and SP2 (without code protection):

- Press SET key. Out1 LED and out1 set point value will flash on the display.
- Modify the out1 set point value using the UP and DOWN keys.
- Press SET key to store the out1 set point value and advance to out2 set point value.
- Modify the out2 set point value using the UP and DOWN keys.
- Press SET key to store the value and return to home screen.

Access to all parameters (code protected):

- Press SET for 8 seconds. The access code value 0 is shown on the display.
- Using the UP and DOWN buttons, set the code (factory-set code is 0).
- Press SET to confirm the code. If it is correct, the first parameter label will be shown on the display (SP1).
- Move to the desired parameter with the UP and DOWN keys.
- Press SET to see the value of the parameter.
- Modify the value with the UP and DOWN keys.
- Press SET to store value.
- Press SET and DOWN to quit programming, or wait 1 minute for the TIMEOUT.

Resetting the parameter pass code

The parameter code can be set to zero by holding the SET key and turning the controller off then on again.

LED INDICATIONS

Out1: Indicates relay 1 On or Off as per parameter H2. If H2=dir, with relay 1 On, LED lit, if H2=inv, with relay 1 On, LED off. It blinks when SP1 is displayed.

Out2: Indicates relay 2 On or Off as per parameter H3. If H3=dir, with relay 2 On, LED lit, if H3=inv, with relay 2 On, LED off. It blinks when SP2 is displayed.

Error Messages

Under normal operation, the temperature of the probe selected by P4 will be displayed, the following messages may also appear:

- **Err** Memory reading error.
- **ErP** Error of the probe not shown on the display.
- **AH1** Maximum temperature alarm, probe 1.
- **AL1** Minimum temperature alarm, probe 1.
- **AH2** Maximum temperature alarm, probe 2.
- **AL2** Minimum temperature alarm, probe 2.
- **ooo** Open probe.
- **---** Shorted probe.

Pressing SET and UP keys simultaneously will display the temperature of the probe not selected by P4 will be displayed. When the probe not selected by P4 is displayed, it alternates its value with message Sd1 or Sd2 depending if it is probe 1 or probe 2. Pressing SET and DOWN keys simultaneously will cancel. The display blinks when waiting for a value confirmation.

Silence the Buzzer

Pressing the SET and DOWN keys simultaneously silences the buzzer. The message of alarm continues appearing in the display.

Resetting Parameters to Factory Values

- Access parameter H0 as explained in programming parameters.
- Value 0 will be displayed.
- Press SET for 8 seconds. Pro will be displayed if they have been setup correctly.
- Press SET + DOWN to exit setup or wait for 1 minute.

Parameter List

	Description	Units	Range	Factory Value
SP1	Set point 1	Degrees	r4 to r6	10.0
SP2	Set point 2	Degrees	r5 to r7	10.0
r0	Dependency SP1 to SP2	Option	Ind or dep	ind
r1	Differential for SP1	Degrees	0.1 to 20.0	1.0
r2	Differential for SP2	Degrees	0.1 to 20.0	1.0
r3	Band differential	Degrees	0.1 to 20.0	1.0
r4	Lowest value for SP1	Degrees	-99.9 to r6	-99.9
r5	Lowest value for SP2	Degrees	-99.7 to r7	-99.9
r6	Highest value for SP1	Degrees	r4 to 302	302
r7	Highest value for SP2	Degrees	r5 to 302	302
r8	Regulation or Operating Mode	Option	On1, On2, nEU	On1
A0	Alarm Differential	Degrees	0.1 to 20.0	0.1
A1	Maximum alarm probe 1	Degrees	0.1 to 99.9	99.9
A2	Maximum alarm probe 2	Degrees	0.1 to 99.9	99.9
A3	Minimum alarm probe 1	Degrees	0.1 to 99.9	99.9
A4	Minimum alarm probe 2	Degrees	0.1 to 99.9	99.9
A5	Alarm verification time	h-m(*)	0.0 to 18.0	18.0
A6	Alarm probe 1 selection	Option	AHL, Ano, AH, AL	AHL
A7	Alarm probe 2 selection	Option	AHL, Ano, AH, AL	AHL
c0	Minimum relay stop time	Minutes	0 to 240	0
c1	Operation relay 1	Option	dir or inv	dir
c2	Operation relay 2	Option	dir or inv	dir
c3	Fail Safe Operation relay 1	Option	Opn or Clo	Opn
c4	Fail Safe Operation relay 2	Option	Opn or Clo	Opn
P0	Temperature Units Selection	Option	°C or °F	°C
P1	Calibration Probe 1	Degrees	-20 to 20	0.0
P2	Calibration Probe 2	Degrees	-20 to 20	0.0
P3	Decimal Point	Option	no or yes	yes
P4	Probe to be displayed	Option	sd1 or sd2	sd1
P5	Number of Probes	Option	1 or 2	1
H0	Factory Reset Values	Option	0	0
H1	Keypad tamper protection	Option	no or yes	no
H2	Operation of Out1 LED	Option	dir or inv	dir
H3	Operation of Out2 LED	Option	dir or inv	dir
H4	Address for serial communication	Range	0-999	0
H5	Access code to parameters	Range	0-999	0
H6	Probe Type Selection	Option	Ptc or ntc	PTC

(*) h-m are data in format XX.Y where XX are hours and Y tens of minutes.

PARAMETER DESCRIPTIONS

SP1=Setpoint of relay 1. Variable between r4 and r6.
SP2=Setpoint of relay 2. Variable between r5 and r7.
r0=Dependency between SP1 and SP2. Only for mode ONOFF1
 Ind=set point for relay 2, SP2.
 dep=set point for relay 2, SP1+SP2.
r1=Differential or hysteresis for relay 1. Temperature differential between ON/OFF of relay 1 in ON/OFF control.
r2=Differential or hysteresis for relay 2. Temperature differential between ON/OFF of relay 2 in ON/OFF control.
r3=Band differential. Temperature differential between ON/OFF of relays 1 and 2 in neutral area control. For relay 1 it is added to SP1 and for relay 2 it is subtracted from SP1.
r4=Lowest value for SP1.
r5=Lowest value for SP2.
r6=Highest value for SP1.
r7=Highest value for SP2.
r8=Regulation or operating mode. Selection of the operating mode.
A0=Alarm differential. It is the temperature differential between the alarm On and Off cycle.
A1=Maximum alarm probe1.
 Maximum alarm ON when probe 1 higher than SP1+A2
 Maximum alarm OFF when probe 1 lower than SP1+A2-A0.
A2=Maximum alarm probe2.
 Maximum alarm ON when probe 2 higher than SP2+A2
 Maximum alarm OFF when probe 2 lower than SP2+A2-A0.
A3=Minimum alarm probe1.
 Minimum alarm ON when probe 1 lower than SP1-A3
 Minimum alarm OFF when probe 1 higher than SP1-A3+A0.
A4=Minimum alarm probe2.
 Minimum alarm ON when probe 2 lower than SP2-A4
 Minimum alarm OFF when probe 2 higher than SP2-A4+A0.
A5=Alarm verification time. Time from the alarm event until it trips.
A6=Alarm probe 1 selection. (See Figure 3).
 AHL=Maximum and minimum alarm probe 1 enabled.
 Ano=No alarms probe 1.
 AH=Maximum alarm probe 1 enabled.
 AL=Minimum alarm probe 1 enabled.
A7=Alarm probe 2 selection. (See Figure 3).
 AHL=Maximum and minimum alarm probe 2 enabled.
 Ano=No alarms probe 2.
 AH=Maximum alarm probe 2 enabled.
 AL=Minimum alarm probe 2 enabled.

c0 = Minimum relay stop time. Minimum time from the disconnection of a relay until it can be switched on again.
c1 = Operation relay 1. Selection between direct or reverse operation for relay 1.
c2 = Operation relay 2. Selection between direct or reverse operation for relay 2.
c3 = Default operation relay 1. In case of failure of probe 1:
 oPn= relay 1 will remain open.
 Clo= relay 1 will remain closed.
c4 = Default operation relay 2. In case of failure of probe 1 (for all modes excepting ON OFF2) or in case of failure of probe 2 (for mode ON OFF2):
 oPn= relay 2 will remain open.
 Clo= relay 2 will remain closed.
P0 = Temperature scale selection.
P1 = Calibration of probe 1. Offset degrees to be added to probe 1.
P2 = Calibration of probe 2. Offset degrees to be added to probe 2.
P3 = Decimal point. If the displayed value of the probes is desired with decimals or not.
P4 = Probe to be displayed. Probe always on the display. The other probe can be seen pressing the keys SET+UP.
 sd1= probe 1.
 sd2= probe 2.
P5 = Number of probes. If P5=1, there is no ONOFF2 mode. If selected, it will operate as ONOFF1.
H0 = Reprogramming. Parameter to reprogram the thermostat.
H1 = Keyboard protection.
 To change the settings, enter into parameter and exit again. The protection setting is momentarily released. It switches on again 1 minute after the last time a key was pressed.
 Yes = Keyboard Protected.
 No = Keyboard non protected.
H2 = Operation of LED OUT1.
 dir = On when relay 1 is ON.
 inv = On when relay 1 is OFF.
H3 = Operation of LED OUT2.
 dir = On when relay 2 is ON.
 inv = On when relay 2 is OFF.
H4 = Serial communication address. Address for computer connection.
H5 = Parameter entry code. Factory set as 0.

MAINTENANCE

After final installation of the TSW Series Digital Temperature Switch, no routine maintenance is required. A periodic check of system calibration is recommended. The devices are not field repairable and should be returned to the factory if recalibration or other service is required. After first obtaining a Returned Goods Authorization (RGA) number, send the material, freight prepaid, to the following address. Please include a clear description of the problem plus any application information available.

Dwyer Instruments, Inc.
 Attn: Repair Department
 102 Highway 212
 Michigan City, IN 46360 U.S.A.

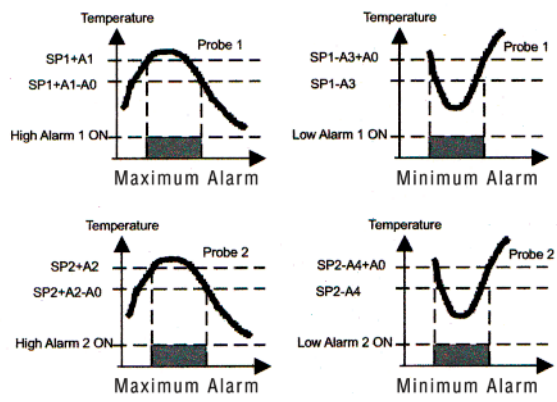

Figure 3

Operating modes

Mode ON OFF1 (On1) with r0=ind.

Relay 1 with c1=dir.

Temperature of probe 1 \geq SP1+r1 -->relay 1 ON
 Temperature of probe 1 \leq SP1 -->relay 1 OFF

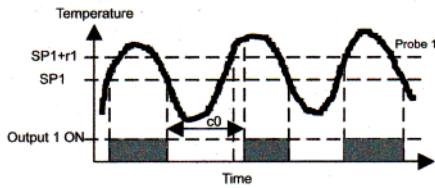

Figure 1

Relay 1 with c1=inv.

Temperature of probe 1 \leq SP1-r1 -->relay 1 ON
 Temperature of probe 1 \geq SP1 -->relay 1 OFF

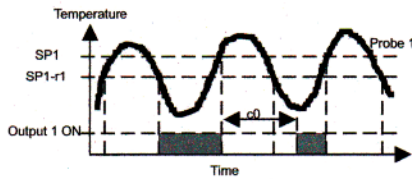

Figure 2

Relay 2 with c2=dir.

Temperature of probe 1 \geq SP2+r2 -->relay 2 ON
 Temperature of probe 1 \leq SP2 -->relay 2 OFF

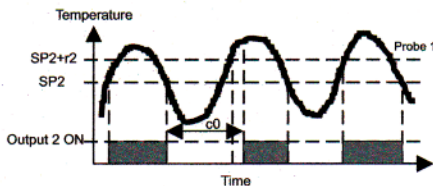

Figure 3

Relay 2 with c2=inv.

Temperature of probe 1 \leq SP2-r2 -->relay 2 ON
 Temperature of probe 1 \geq SP2 -->relay 2 OFF

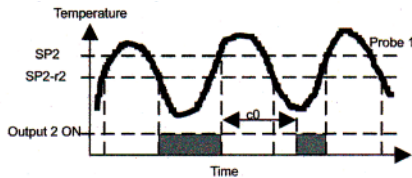

Figure 4

Mode ON OFF1 (On1) with r0=dep.

Output 1 works as an independent ON/OFF control (Figure 1 and 2), but output 2 works as follows:

Relay 2 with c2=dir.

Temperature of probe 1 \geq SP1+SP2+r2 -->relay 2 ON
 Temperature of probe 1 \leq SP1+SP2 -->relay 2 OFF

Relay 2 with c2=inv.

Temperature of probe 1 \leq SP1+SP2-r2 -->relay 2 ON
 Temperature of probe 1 \geq SP1+SP2 -->relay 2 OFF

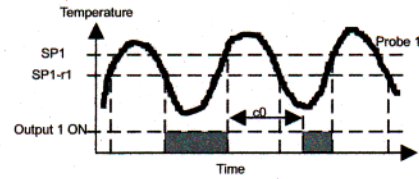

Figure 2

Mode ON OFF2 (On2)

Output 1 works as an independent ON/OFF control (Figure 1 and 2), but output 2 works as follows:

Relay 2 with c2=dir.

Temperature of probe 2 \geq SP2+r2 -->relay 2 ON
 Temperature of probe 2 \leq SP2 -->relay 2 OFF

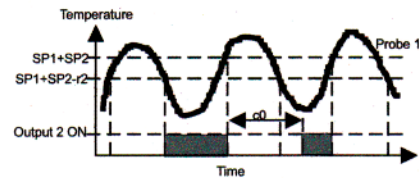

Figure 6

Relay 2 with c2=inv.

Temperature of probe 2 \leq SP2-r2 -->relay 2 ON
 Temperature of probe 2 \geq SP2 -->relay 2 OFF

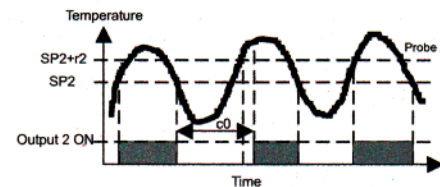

Figure 7

Neutral Area Mode (nEU)

Relay 1

Temperature of probe 1 \geq SP1+r3 -->relay 2 ON
 Temperature of probe 1 \leq SP1 -->relay 2 OFF

Relay 2

Temperature of probe 1 \leq SP1-r3 -->relay 2 ON
 Temperature of probe 1 \geq SP1 -->relay 2 OFF

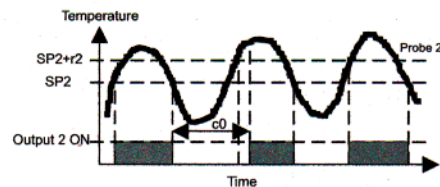

Figure 7

Operation in case of error.

If probe 1 fails, the operation is through c3. (See Parameter description.)
 If probe 2 fails, the operation is through c4. (See Parameter description.)
 In case of memory failure, both relays will remain open.