



UDP3305S Series Programmable DC Power Supply User Manual



Preface

Thank you for choosing Uni-T brand new product. To safely operate this equipment, please review this manual thoroughly, pay close attention to the safety notes.

After reading this manual, it is recommended to keep the manual at an easily accessible place, preferably close to the device, for future reference.

Limited Warranty and Liability

Uni-Trend guarantees that the product is free from any defect in material and workmanship within three years from the purchase date. This warranty does not apply to damages caused by accident, negligence, misuse, modification, contamination or improper handling. The dealer shall not be entitled to give any other warranty on behalf of Uni-Trend. If you need warranty service within the warranty period, please contact your seller directly. Uni-Trend will not be responsible for any special, indirect, incidental or subsequent damage or loss caused by using this device.

Copyright Information

Copyright is owned by Uni-Trend Technology (China) Co., Ltd.

UNI-T products are protected by patent rights in China and other countries, including issued and pending patents. Uni-Trend reserves the rights to any product specification and pricing changes.

Uni-Trend Technology (China) Co., Ltd. all rights reserved. Trend reserves all rights. Information in this manual supersedes all previously published versions. No part of this manual may be copied, extracted or translated by any means without the prior permission of Uni Trend.

UNI-T is the registered trademark of Uni Trend Technology (China) Co., Ltd.

Warranty Service

The instrument has a warranty period of three years from the date of purchase. If the instrument is damaged due to improper operation by the user during the warranty period, the maintenance fee and the costs caused by the maintenance shall be borne by the user, and the instrument shall be maintained by the company for life.

If the original purchaser sells or transfers the product to a third party within three years from the date of purchase of the product, the warranty period of three years shall be from the date of the original purchase from UNI-T or an authorized UNI-T distributor. Power cords, accessories and fuses, etc. are not included in this warranty.

If the product is proved to be defective within the warranty period, UNI-T reserves the rights to either repair the defective product without charging of parts and labor, or exchange the defected product to a working equivalent product (determined by UNI-T). Replacement parts, modules and products may be brand new, or perform at the

same specifications as brand new products. All original parts, modules, or products which were defective become the property of UNI-T.

The "customer" refers to the individual or entity that is declared in the guarantee. In order to obtain the warranty service, "customer" must inform the defects within the applicable warranty period to UNI-T, and perform appropriate arrangements for the warranty service.

The customer shall be responsible for packing and shipping the defective products to the individual or entity that is declared in the guarantee. In order to obtain the warranty service, customer must inform the defects within the applicable warranty period to UNI-T, and perform appropriate arrangements for the warranty service. The customer shall be responsible for packing and shipping the defective products to the designated maintenance center of UNI-T, pay the shipping cost, and provide a copy of the purchase receipt of the original purchaser. If the products is shipped domestically to the purchase receipt of the original purchaser. If the product is shipped to the location of the UNI-T service center, UNI-T shall pay the return shipping fee. If the product is sent to any other location, the customer shall be responsible for all shipping, duties, taxes, and any other expenses.

Limited Warranty and Liability

The warranty is inapplicable to any defects, failures or damages caused by accident, normal wear of components, use beyond specified scope or improper use of product, or improper or insufficient maintenance. UNI-T is not obliged to provide the services below as prescribed by the warranty:

- a) Repair damage caused by installation, repair or maintenance of personnel other than service representatives of UNI-T;
- b) Repair damage caused by improper use or connection to incompatible equipment;
- c) Repair any damages or failures caused by using power source not provided by UNI-T;
- d) Repair products that have been changed or integrated with other products (if such change or integration increases time or difficulty of repair).

The warranty is formulated by UNI-T for this product, replacing any other express or implied warranties. UNI-T and its distributors refuse to give any implied warranty for marketability or applicability for special purpose. For violation of the warranty, repair or replacement of defective products is the only and all remedial measure UNI-T provides for customers. No matter whether UNI-T and its distributors are informed of any possible indirect, special, occasional or inevitable damage in advance, they assume no responsibility for such damage.

Safety Information

 **Warning**  **Danger:**

To avoid electric shock and personal injury, please follow the following guidelines.

Disclaimer

Please read the following safety information carefully before using the instrument. UNI-T will not be liable for the

personal injury and property losses caused by the user's failure to comply with the following terms.

Correct connection of ground wire

To avoid electric shock, please use the provided cable to connect and make sure that the product is properly grounded before use.

Operating voltage

Please ensure that the main supply does not exceed 10% of rated operating range to prevent product damage.

Input voltage

Please notice the product symbols before connecting. The instrument supports 2 kinds of AC input method: 110V and 220V. Please check if the switch of load matches with the input power source and if the fuse is correctly installed.

Leads

Check whether the insulation layer of the test leads is damaged or whether the leads are exposed or conducting. If the leads are damaged, replace them.

Fuses

Only fuses specified for this product are allowed.

Overvoltage protection

Please ensure that no excessive voltage (such as the voltage caused by lightning) reaches the product to avoid electric shock.

Do not open the housing of the product.







Do not operate the product when the instrument case is open. Do not alter the internal circuit of the instrument.

Do not touch live parts.

Do not touch exposed connectors, unused input terminals, or circuits being measured while the instrument is in use.

Please do not use the instrument in inflammable and explosive environment.

Do not use or store the instrument in high temperature, high humidity, flammable, explosive and strong magnetic field environments.

	Grounding		Power on
	Protective grounding		Power off
	Signal grounding		Ground terminal for chassis
	Danger		

Environment-Friendly Use Period (EFUP)



This product contains certain hazardous substances and can be used safely during its environmental-friendly use period (EFUP) of 40 years, as shown in the symbol on the left. If the specified time is exceeded, the product should be recovered.



Waste Electrical and Electronic Equipment (WEEE) Instruction 2002/96/EC



Do not dispose the product and its accessories in trash bin.

1. Product Overview

This chapter includes:

-  Product Series (Features and Specifications)
-  Front Panel
-  Rear Panel

3.11 Product Series

UDP3305S series programmable DC power supply includes two models: UDP3305S and UDP3305S-E. The output ranges are shown in the table below:

Model	Maximum output voltage	Maximum output current
UDP3305S	CH1: 33V	CH1: 5.2A
	CH2: 33V	CH2: 5.2A
UDP3305S-E	CH3: 6.2V	CH3: 3.2A
	CH4: 5V	CH4: 2A

UDP3305S series is a high-performance programmable DC power supply with a clear interface, excellent performance indexes, multiple analysis functions and communication interfaces, which can meet diverse testing requirements.

1.1.1 Features

- The maximum power can reach 373W, and the output of each channel is individually controllable.

- Four-channel independent output: CH1/CH2: 0~30V/5A, CH3: 0~6V/3A, CH4: 5V/2A (USB)
- Multi-protection: over voltage/over current/over temperature protection
- CH1/CH2/CH3 independent output switch
- Excellent load regulation and line regulation
- Ultra-low output ripple and noise
- Internal series and parallel connection output function
- Voltage and current linear programmable functions
- 4.3" TFT display, which can display multiple parameters and three-channel status at the same time
- List mode/delayer, can control voltage and current output according to users' needs
- External trigger function to realize industrial automation control
- USB Host, USB Device, LAN, RS232, Digital IO interfaces
- With a waveform display function, the instrument can display the output voltage/current waveform in real time, and cooperate with the digital display of the voltage, current and power values, which is convenient for users to know the output status and trend of the instrument.
- The instrument can automatically control the fan speed according to the operating conditions to reduce the noise.
- Fan fault detection and alarm function
- 10 sets of settings to save and recall, supports U disk read and storage
- Five-digit voltage/four-digit current high-precision display, resolution: 1mV/1mA
- Key lock function to prevent accidental touch
- Supports SCPI remote command control

1.1.2 Specifications

Technical indexes			
Models		UDP3305S-E	UDP3305S
Output rating	Voltage	CH1&CH2: 0 ~ 32V×2 CH3: 0 ~ 6V CH4: 5V (USB output)	CH1&CH2: 0 ~ 32V×2 CH3: 0 ~ 6V CH4: 5V (USB output)
	Current	CH1&CH2: 0 ~ 5A×2 CH3: 0 ~ 3A×1 CH4: 2A (USB output)	CH1&CH2: 0 ~ 5A×2 CH3: 0 ~ 3A×1 CH4: 2A (USB output)
	Power	348W	348W
Constant voltage mode	Regulation	Power supply regulation: ≤0.01%+2mV	Power supply regulation: ≤0.01%+2mV
		Load regulation: ≤0.01%+2mV	Load regulation: ≤0.01%+2mV
	Ripple and noise	< 350μVrms/2mVpp(5Hz~1MHz)	< 350μVrms/2mVpp(5Hz~1MHz)
	Response time	≤50μs(50% load variation, minimum load 0.5A)	≤50μs(50% load variation, minimum load 0.5A)

	Command processing time	< 100ms	< 100ms
	Output range	Adjustable continuously from 0 to rated voltage	Adjustable continuously from 0 to rated voltage
Constant current mode	Regulation	Power supply regulation: $\leq 0.01\% + 250\mu\text{A}$	Power supply regulation: $\leq 0.01\% + 250\mu\text{A}$
		Load regulation: $\leq 0.01\% + 250\mu\text{A}$	Load regulation: $\leq 0.01\% + 250\mu\text{A}$
	Ripple current	$\leq 2\text{mArms}$	$\leq 2\text{mArms}$
	Output range	Adjustable continuously from 0 to rated current	Adjustable continuously from 0 to rated current
Tracking mode	Parallel connection	Power supply regulation: $\leq 0.01\% + 2\text{mV}$	Power supply regulation: $\leq 0.01\% + 2\text{mV}$
		Load regulation: $\leq 0.01\% + 2\text{mV}$	Load regulation: $\leq 0.01\% + 2\text{mV}$
	Series connection	Power supply regulation: $\leq 0.01\% + 3\text{mV}$	Power supply regulation: $\leq 0.01\% + 3\text{mV}$
		Load regulation: $\leq 300\text{mV}$	Load regulation: $\leq 300\text{mV}$
	Tracking error	$\leq 0.5\% + 10\text{mV}$ (10~30V no load)	$\leq 0.5\% + 10\text{mV}$ (10~30V no load)
		$\leq 0.5\% + 30\text{mV}$ (0~9.99V no load) Connected load $\leq 300\text{mV}$	$\leq 0.5\% + 30\text{mV}$ (0~9.99V no load) Connected load $\leq 300\text{mV}$
Measurement	Display	Voltage full scale, 4 digits display; LCD	Voltage full scale, 5 digits display; LCD
		Current full scale, 4 digits display; LCD	Current full scale, 4 digits display; LCD
	Programming resolution	Voltage: 10mV	Voltage: 1mV
		Current: 1mA	Current: 1mA
	Read back resolution	Voltage: 10mV	Voltage: 1mV
		Current: 1mA	Current: 1mA
	Programming accuracy (25±5°C)	Voltage: $\pm (0.3\% + 20\text{mV})$	Voltage: $\pm (0.03\% + 10\text{mV})$
		Current: $\pm (0.2\% + 5\text{mA})$	Current: $\pm (0.2\% + 5\text{mA})$
	Read back accuracy (25±5°C)	Voltage: $\pm (0.1\% + 20\text{mV})$	Voltage: $\pm (0.03\% + 10\text{mV})$
		Current: $\pm (0.15\% + 5\text{mA})$	Current: $\pm (0.15\% + 5\text{mA})$

Voltage programmed speed (1% of total variation range)	CH1	Rise: full load < 50ms; no-load < 30ms	Rise: full load < 50ms; no-load < 30ms
		Fall: full load < 45ms; no-load < 400ms	Fall: full load < 45ms; no-load < 400ms
	CH2	Rise: full load < 50ms; no-load < 30ms	Rise: full load < 50ms; no-load < 30ms
		Fall: full load < 45ms; no-load < 400ms	Fall: full load < 45ms; no-load < 400ms
	CH3	Rise: full load < 15ms; no-load < 13ms	Rise: full load < 15ms; no-load < 13ms
		Fall: full load < 22ms; no-load < 100ms	Fall: full load < 22ms; no-load < 100ms
Temperature coefficient per°C	CH1	Voltage: 0.01%+5mV; Current: 0.01%+2mA	Voltage: 0.01%+5mV; Current: 0.01%+2mA
	CH2	Voltage: 0.01%+5mV; Current: 0.01%+2mA	Voltage: 0.01%+5mV; Current: 0.01%+2mA
	CH3	Voltage: 0.01%+2mV; Current: 0.01%+2mA	Voltage: 0.01%+2mV; Current: 0.01%+2mA
Channel 4 (USB output) indicator	Output voltage	5V ±0.25V	5V ±0.25V
	Output current	2A	2A

3.12 Front Panel

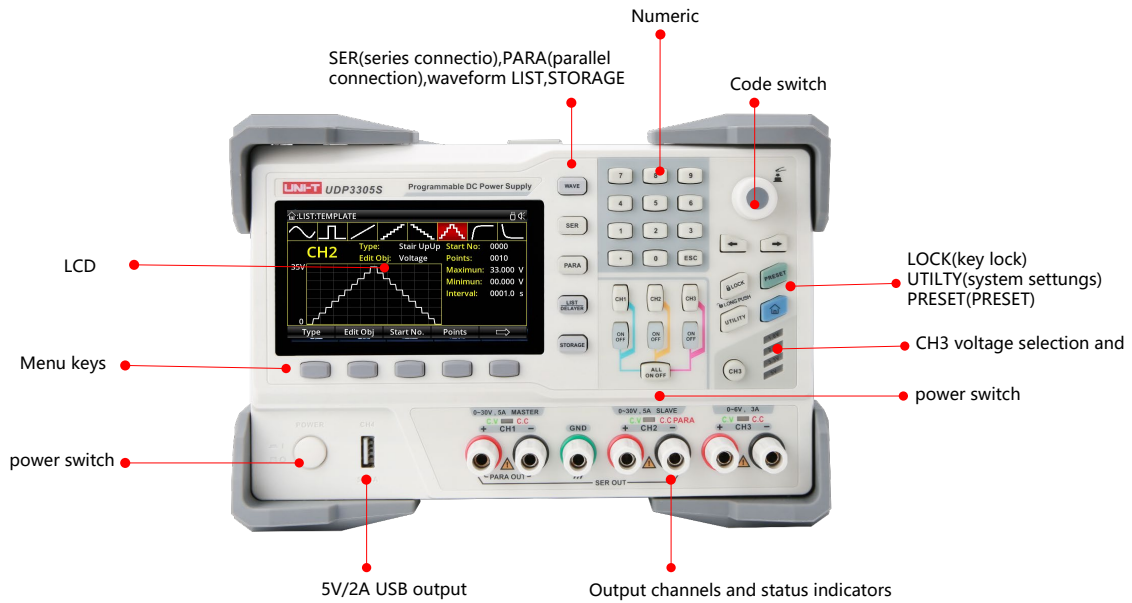

1.2.1 Keys



Key	Function
WAVE	Enable the waveform display function

SER	Enable or disable the series connection function
PARA	Enable or disable the parallel connection function
LIST/DElayer	Enable and switch between list mode or delayer
STORAGE	Internal and external storage and recall
Numeric keys	Input the number or decimal point
ESC	Exit the current interface and return to the previous interface
CH1	Select channel 1
CH2	Select channel 2
CH3	Select channel 3 and switch between 1.8V, 2.5V, 3.3V, 5V
ON OFF	Enable or disable the output of the corresponding channel
ALL ON OFF	Enable or disable the outputs of all the channels
Knob	Select or edit the parameter, press it to confirm
←	Step through parameters towards the left
→	Step through parameters towards the right
LOCK	Push to lock, long push to unlock
PRESET	Preset parameters of channels, series, parallel connection
UTILITY	System settings; set backlight, trigger detector, upper connection
	Return to the system main interface
Multi-function buttons	According to the prompt at the bottom of the display, press to select the corresponding function

3.13 Rear Panel

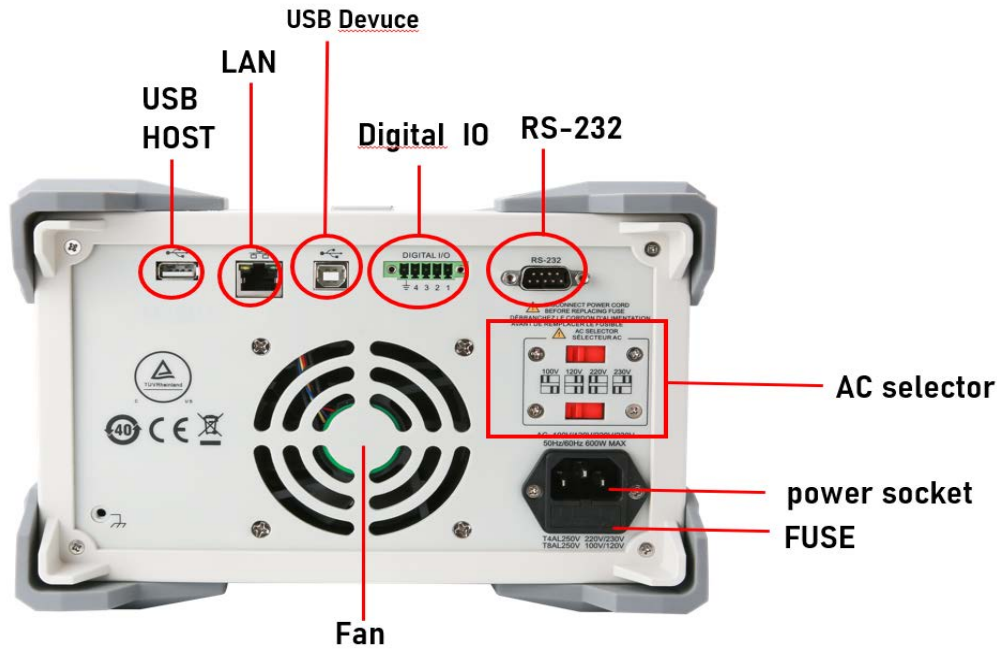

2. Inspection and Installation

This chapter includes:

- ✚ Packing List
- ✚ Requirements for Power Supply
- ✚ Operating Environment
- ✚ Cleaning

3.11 Packing List

Before using the instrument:

1. Check whether the appearance of the product is damaged, scratched or has other defects;
2. Check whether accessories are complete according to the packing list.

If it is damaged or the accessories are missing, please contact Uni-Trend Instrument Sales Department or the distributor immediately.

Accessories	Quantity	Remarks
Programmable DC power supply	1	The model is subject to the actual order.
3C power cord	1	
250V/4A spare fuse	1	Only applicable to 220V input voltage
User manual/ upper	1	Users can download them from

computer software		UNI-T's official website.
USB cable	1	

3.12 Requirements for Power Supply

UDP3305S series can only be used in following conditions:

Parameters	Requirements
Voltage	AC 100V/120V/220V/230V±10%
Frequency	50/60Hz
Power	MAX 600W
Fuse	AC220V input voltage: T4AL250V AC110V input voltage: T8AL250V

- Three-core power cord is provided. Please make sure that the ground wire of three-phase socket is properly grounded before use.
- 250V/4A (5x20mm) fuse is selected and installed for the instrument (220V) with a spare fuse in the fuse case.
- When replacing the fuse, please remove the external power cord first, then open the fuse slot under the power interface, take out the old fuse and replace it with a new one, and install the fuse slot back after completion.



Warning: Please do not use the damaged power cord.

3.13 Operating Environment

UDP3305S series can only be used in normal temperature and low condensing zone. The general environment requirements are listed as follows.

Environment	Requirements
Operating temperature	0°C~40°C
Operating humidity	20%~80% (non-condensing)
Storage temperature	-10°C~60°C
Altitude	≤2000m
Degree of pollution	II

3.14 Cleaning

To avoid electric shock, please unplug the power cord before cleaning.

Clean the housing and the panel with a soft damp cloth, and make sure it is completely dry.



Note: Do not use solvents like alcohol and gasoline.

3. Preparation for Start-Up

This chapter includes:

- ✚ Power on and Run
- ✚ Output Terminals
- ✚ User Interface

3.1 Power on and Run

Before connecting the power supply, make sure that the input AC selector switch on the rear panel is consistent with the actual connected voltage, and the frequency is 50Hz or 60Hz.

Note: If the instrument is damaged due to the wrong AC input, it will not be covered by the product warranty.

Before plugging in the power cord, make sure that the power switch on the front panel is off.

Connect the power cord to the AC power input terminal and the three-hole AC power output terminal on the rear panel (AC power supply with grounding wire).

Warning: The three-hole power cord that comes with the instrument has an independent grounding terminal. The power supply used must be three-hole and grounded, otherwise, it may cause electric shock. Press the power switch to power on the instrument.

3.2 Output Terminals



1. Each channel can be used as an independent channel.
2. When CH1 and CH2 are connected in series or in parallel, pay attention to the wiring configuration.
3. The green indicator of each channel indicates the constant voltage mode, and the red indicates the constant current mode.

3.3 User Interface

3.3.1 Layout

After turning on the instrument, it will enter the user interface, as shown in the figure below.

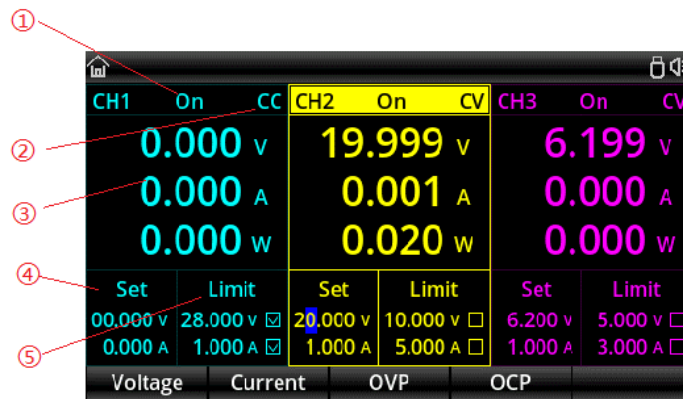

3.3.2 Explanation

NO.	Name	Explanation
①	Channel output status	ON/OFF
②	Channel output mode	CV/CC mode
③	Output voltage/current /power	Display the actual voltage/current/ power
④	Voltage and current setting window	Voltage and current setting
⑤	Voltage and current limit setting window	Overvoltage and overcurrent protection setting values

4 Front Panel Operations

This chapter includes:

- ✚ Constant Voltage Output
- ✚ Constant Current Output
- ✚ Power Supply Series and Parallel Connections
- ✚ List Mode and Delayer
- ✚ Advanced Functions
- ✚ Display Setting
- ✚ Store and Recall
- ✚ System Settings

4.1 Constant Voltage Output

UDP3305S series power supply provides two output modes: constant voltage output (CV) and constant current output (CC). In CV mode, the output voltage is maintained at the voltage setting value and the output current is determined by the load. In CC mode, the output current is maintained at the current setting value and the output voltage is determined by the load (When the power supply setting limit current value is less than the current value consumed by the load,

the power supply is in constant current mode).

This section introduces the operation method in constant voltage output mode.



Setting Interface

Operation steps:

1. Press the power switch to power on the instrument.
2. Select the channel:

Select the channel according to the voltage and current required by the load. Press the corresponding channel selection key; at this point, this channel and its output state are high-lighted on the screen.
3. Connect the load:

Use leads with appropriate gauge size to connect the load to the selected channel.
4. As shown in the figure below, connect the load with the channel output terminals of the corresponding channel at the front panel.

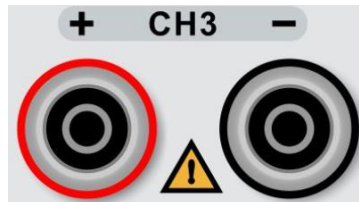



Caution



Pay attention to the polarity when connecting them to avoid damaging the instrument and the devices connected to the instrument.

5. Set the voltage and current:

Method 1

Press the "Voltage" or "Current" key, and the cursor will be displayed at the end of the voltage or current setting value. Press  or  to select the voltage digit to be adjusted, and rotate the knob to set the value of each digit.

Method 2

Press the "Voltage" or "Current" key, and the cursor will be displayed at the end of the voltage setting value. Input the desired voltage by using the numeric keys, and press  to delete. The voltage can be set by pressing the

corresponding key through the prompt unit V or mV at the bottom of the screen.

6. Set overvoltage and overcurrent protection:

The method is the same as the voltage and current setting. After setting the values, press the "Overvoltage" or "Overcurrent" key to turn on/off the overvoltage and overcurrent protection.

Note: means turning on the protection, and means turning off the protection.

7. Turn on the output:

Press the  key to turn on the output of the corresponding channel and the actual output voltage, output current, ON/OFF state, output power as well as the output mode (CV/CC) are high-lighted in the user interface.

8. Check the output mode:

In constant voltage output mode, the output mode displayed should be "CV"; if "CC" is displayed, users can increase the current setting value properly and the power supply will switch to CV mode automatically.

4.2 Constant Current Output

Operation steps:

1. Press the power switch to power on the instrument.

2. Select the channel:

Select the channel according to the voltage and current required by the load. Press the corresponding channel selection key; at this point, this channel and its output state are high-lighted on the screen.

3. Connect the load:

Connect the load to the selected channel.

4. Set the voltage:

It is the same as setting voltage in constant voltage mode.

5. Set the current:

It is the same as setting current in constant voltage mode.

6. Set overvoltage and overcurrent protection:

It is the same as setting overvoltage and overcurrent protection in constant voltage mode.

7. Turn on the output:

Turn on the output of the corresponding channel and the actual output voltage, output current, output power as well as the output mode (CC) are high-lighted in the user interface.

8. Check the output mode:

In constant current output mode, the output mode displayed should be "CC"; if

"CV" is displayed, users can decrease the current setting value properly and the power supply will switch to CC mode automatically.

4.3 Power Supply Series and Parallel Connections

Higher voltages can be attained when two or more insulated channels (the channels can be from a single power supply or multiple power supplies) are connected in series. Higher currents can be provided when two or more insulated channels (the channels can be from a single power supply or multiple power supplies) are connected in parallel. UDP3305S series power supply's series and parallel connections do not require external wiring  press "

" or " " to realize the connections, but it is limited to the series and parallel connections between CH1 and CH2. If users need to connect the UDP3305S series power supply in series and parallel with other power supply channels, they can only achieve it through external wiring, as shown in the figure below, please pay close attention to the following points.

Note:

1. Only insulated channels can be connected in series or in parallel.
2. In power supply series and parallel connections, the settings of the corresponding parameters must comply with the safety requirements.

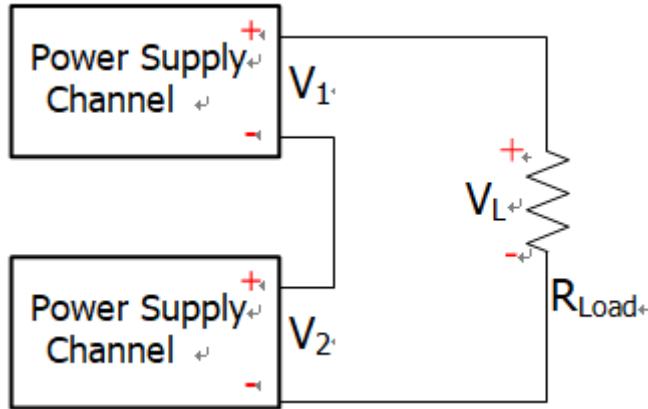

When two insulated channels are connected in series: $V_L = V_1 + V_2$

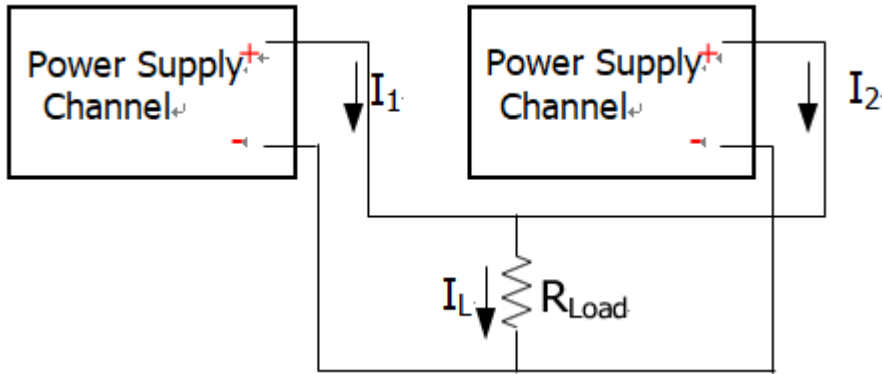

When two insulated channels are connected in parallel: $I_L = I_1 + I_2$

Power Supply Series Connection

Higher voltages can be achieved by connecting power supplies in series. In this case, the output voltage is the sum of the output voltages of all the channels. When the UDP3305S series power supply enters the series mode, users only need to set its output voltage, output current, and the overvoltage and overcurrent protection values.



Series Connection Setting Interface

Operation steps:

1. Press the power switch to power on the instrument.
2. Enter series mode:
Press “SER”, and the screen will display that CH1 and CH2 enter the series mode. The key backlight lights up, and SER appears on the screen with a wiring diagram.
3. Connect the load:
Connect the load according to the wiring diagram on the screen. Connect the positive pole of the load to the positive pole (red) of the CH1 output terminal, and connect the negative pole of the load to the negative pole (black) of the CH2 output terminal.
4. Set the voltage, current, overvoltage and overcurrent protection:
Refer to chapter "Constant Voltage Output". All the channels in series connection should be operating in constant voltage mode.
5. Turn on the output:
Press the  key of CH1 or CH2 to enter the series connection output mode. At this time, the CH1 and CH2 output indicators are all green (CV mode). If the indicator is red, please check whether the set current meets the load requirements.

Power Supply Parallel Connection

High currents can be achieved by connecting power supplies in parallel. In this case, the output current is the sum of the output currents of all the channels. When the UDP3305S series power supply enters the parallel mode, users only need to set its output voltage, output current, and the overvoltage and overcurrent protection values.



Parallel Connection Setting Interface

Operation steps:

1. Press the power switch to power on the instrument.
2. Enter parallel mode:
Press “PARA”, and the screen will display that CH1 and CH2 enter the parallel mode. The key backlight lights up, and PARA appears on the screen with a wiring diagram.
3. Connect the load:
Connect the load according to the wiring diagram on the screen. Connect the positive pole of the load to the positive pole (red) of the CH1 output terminal, and connect the negative pole of the load to the negative pole

(black) of the CH1 output terminal.

4. Set the voltage, current, overvoltage and overcurrent protection:

Refer to chapter "Constant Voltage Output". All the channels in parallel connection should be operating in constant voltage mode.

5. Turn on the output:

Press the  key of CH1 or CH2 to enter the parallel connection output mode. At this time, the CH1 and CH2 output indicators are green (CV mode) and red (parallel connection or CC mode) respectively. If the CH1 indicator is red too, please check whether the set current meets the load requirements.

4.4 List Mode (Timer and Delayer)

UDP3305S series power supply is equipped with the timer and delayer functions.

When the timer is enabled, the instrument outputs the preset parameter groups (at most 2048 groups): voltage, current and timing time. Users can define the parameter groups by calling the template that comes with the system.

When the delayer is enabled, the instrument outputs the preset parameter groups (at most 2048 groups): enable or disable output and delay time. Users can define the parameter groups by calling the system's automatic generation function.

The output parameters of the list mode and the delayer can be saved in the internal memory of the system. 10 groups can be stored each, and users can define the file name. Users can also store list mode parameters (list mode file, with the suffix ".LST") and delayer parameters with user defined file name (delay file, with the suffix ".DLY ") in external memory. The number of external storage files is not limited by the system, only limited by the size of the external storage space.

Operation steps:

1. Press the power switch to power on the instrument.

2. Enter the timer/delayer mode:

Press  to step through the list mode and delayer setting interface.

Note: For the same channel, the timer function and delayer function are mutually exclusive. When the timer is enabled, delayer is disabled. For different channels, they can be enabled or disabled at the same time.

3. Select the channel:

In timer/delayer mode, CH1, CH2, CH3, series and parallel can be selected as output channels.

When selecting CH1, CH2 or CH3, they can all work independently at the same time.

When selecting series or parallel mode, it can work independently with CH3, but CH1 and CH2 channels cannot be used independently.

4. Connect the load:

Connect the load according to the selected load. Refer to chapter "Power Supply Series and Parallel Connections" for the connection method.

5. Set list mode/delayer parameters:

Refer to the following chapters "List Mode Parameter Setting" and "Delayer Parameter Setting".

6. Turn on the output:

Press  of the corresponding channel to turn on the timing output.

List Mode Parameter Setting

The interface of list mode is as follows:

PARA	Stopped	No.	Volt(V)	Curr(A)	Time(s)
Stopped Start No: 0000 Groups: 2048 Cycles: 00001 End State: Outp Off	0000	1.000	1.000	1.0	
	0001	1.000	1.000	1.0	
	0002	1.000	1.000	1.0	
	0003	1.000	1.000	1.0	
	0004	1.000	1.000	1.0	
	0005	1.000	1.000	1.0	
0006	1.000	1.000	1.0		

Basic Parameter Templet Memory Startup

To set the list mode parameters manually:

Press “Basic parameter” key to enter the setting interface. Users can edit the starting group number, the required number of output groups (maximum 2048 groups), the number of cycles (maximum 99999 times) and the output status after the timing period expires. Set parameters for each group: Set voltage, current, and time parameters for each group based on the desired number of output groups.

To set the list mode parameters using template:

Press “Template” to open the template editing menu.

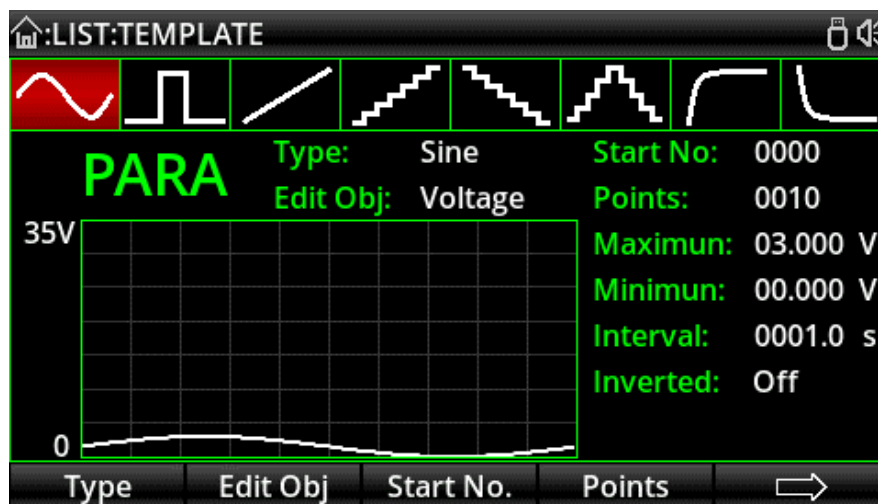

1. Press “Type” to select the desired template;
2. Press “Edit object” to select "Voltage" or "Current";
3. Define waveform start group values and total points;
4. Press “More” to set the waveform parameters such as the voltage, maximum and minimum current, high and low levels, pulse width, period and inversion;
5. Press “Construct” to complete the waveform output setting;
6. Press several times until the instrument returns to the initial interface of the list mode. Press the "Enable" key, the timing output function is set up.

Note: Press to return to the previous menu.

Delayer Parameter Setting

The interface of delayer is as follows:

PARA	Stopped	No.	State	Time(s)
	Stopped	0000	OFF	1.0
		0001	ON	1.0
		0002	OFF	1.0
		0003	ON	1.0
		0004	OFF	1.0
		0005	ON	1.0
		0006	OFF	1.0

Start No: 0000
 Groups: 2048
 Cycles: 00001
 End State: Output Off
 Stop Con: None

Basic Parameter Auto Gen Memory Startup

To set the delayer parameters manually:

Press “Basic parameter” key to enter the setting interface. Users can edit the starting group number, the required number of output groups (maximum 2048 groups), the number of cycles (maximum 99999 times), and conditions for terminating the output state and stopping the delayer. Set parameters for each group: Set voltage, current, and time parameters for each group based on the required number of output groups.

To set the list mode parameters using template:

Press “Auto generation” to open the template editing menu.

PARA	Stopped	No.	State	Time(s)
	Stopped	0000	OFF	1.0
				1.0
				1.0
				1.0
				1.0
				1.0
				1.0

Auto Generate

State Gen Start No: 0000
 Fix Time Points: 2048
 Increase Patt: 0 1 Patt
 Decline

Type Start No. Points Patt Generate

1. Press “Type” to select the desired template;
2. Press “Start group” to edit the start group number;
3. Press "Total points" to set the number of points required for this delay (maximum 2048 points);
4. Press "Mode" or "Time" to set parameters for each template. Press "Mode" to select 01 code (off/on cycle) or 10 code (on/off cycle). Press "Time" to edit time base value, step value, open time and close time, etc. (the menu varies according to different templates).
5. After all parameters are set, press "Generate" to complete the delayer template output setting.
6. Press "Enable", the delayer will control the automatic output of the corresponding channel.

Templates

The list mode and delayer are equipped with multiple output templates. The following sections describe the parameters of each template.

4.5 List Mode Templates

The optional list mode templates include: sine, pulse, ramp, stair up, stair down, stair up down, exponential rise and exponential fall.

1. Sine

The Sine waveform is as shown in the figure below.

The instrument determines the Sine amplitude according to the maximum and minimum currently set and determines the Sine period according to the total number of points (maximum 2048) and the time interval (maximum 99999) currently set.

After the waveform is constructed, set the number of cycles in the list mode interface to continuously output Sine waveforms. The output time is determined by the product of the period and the number of cycles.

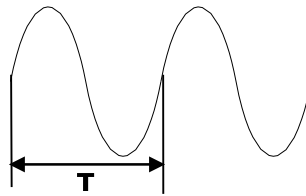

Sine waveform

2. Pulse

The Pulse waveform is as shown in the figure below.

The pulse width t determines the high level duration. The period T determines the Pulse duration. The low level time equals the period T minus the pulse width t ($T-t$).

The high and low level values determine the maximum and minimum amplitudes of the pulse.

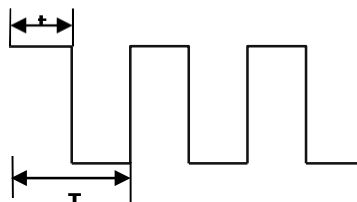

Pulse waveform

3. Ramp

The Ramp waveform is as shown in the figure below.

The difference between the set maximum and minimum values and the time interval (maximum 99999) will determine the slope of the Ramp waveform.

Symmetry indicates the proportion of Ramp waveform rise time to the whole cycle. The ramp-down time is equal to the period minus the product of period and symmetry.

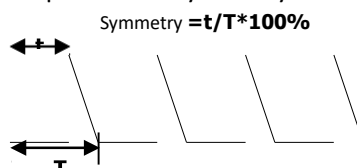

Ramp waveform

4. Stair Up

The Stair Up waveform is as shown in the figure below.

The instrument determines the amplitude of the Ramp according to the maximum and minimum currently set.

The total number of points (N) will divide the amplitude into N-1 steps.

The time interval (maximum 99999) indicates the duration of each step, and determines the waveform period together with the total number of points.

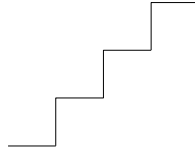

Stair up

5. Stair Down

The Stair Down waveform is as shown in the figure below.

The instrument determines the amplitude of the Ramp according to the maximum and minimum currently set.

The total number of points (N) will divide the amplitude into N-1 steps.

The time interval (maximum 99999) indicates the duration of each step, and determines the waveform period together with the total number of points.

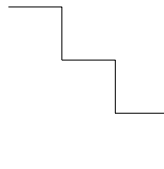

Stair down

6. Stair Up Down

The Stair Up Down waveform is as shown in the figure below.

The instrument determines the amplitude of the Ramp according to the maximum and minimum currently set.

The total number of points (N) will divide the amplitude into N-1 steps. When N is an odd, the number of ascending steps is (N-1)/2 and descending steps is (N-1)/2+1. When N is an even, the number of ascending steps is N/2 and descending steps is N/2.

The time interval (maximum 99999) indicates the duration of each step, and determines the waveform period together with the total number of points.

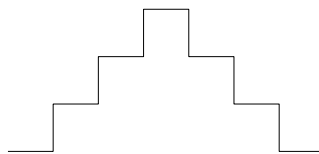

Stair up down

7. Exponential Rise

The Exponential Rise waveform is as shown in the figure below.

The instrument determines the amplitude of the waveform according to the maximum (M) and minimum (N) currently set and determines the waveform period according to the total number of points (P) and the time interval (maximum 99999).

The rise index (R) is the independent variable of the rise function, which is an integer from 0 to 10. It determines the rising speed of the waveform, and the base is Euler number (e=2.718281828).

The waveform function is $f(x) = (M - N)(1 - e^{-\frac{xR}{P}})$ (X is the independent variable, an integer from 0 to P-1).

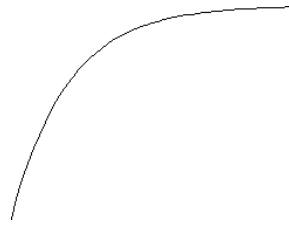

Exponential rise

8. Exponential Fall

The Exponential Fall waveform is as shown in the figure below.

The instrument determines the amplitude of the waveform according to the maximum (M) and minimum (N) currently set and determines the waveform period according to the total number of points (P) and the time interval (maximum 99999).

The fall index (R) is the independent variable of the fall function, which is an integer from 0 to 10. It determines the falling speed of the waveform, and the base is Euler number ($e=2.718281828$).

The waveform function is $f(x) = (M - N)e^{-\frac{xR}{P}}$ (X is the independent variable, an integer from 0 to P-1).

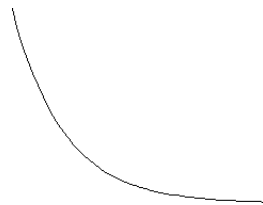

Exponential fall

4.6 Delayer Templates

The optional delayer templates include: state generation, fix time, increase, and decline.

1. State Generation

The state generation mode is a template that controls the On/Off state of the output terminal. "0" means off and "1" means on.

0 1 Pattern: the state is set to "Off" and "On" alternately.

1 0 Pattern: the state is set to "On" and "Off" alternately.

2. Fix Time

Fix time mode is a template for setting the output terminal on time (Max. 99999s) and off time (Max. 99999s).

Users set the output on delay time (the duration when the output status is "On") and the output off delay time (the duration when the output status is "Off").

The default initial state of the group data generated by this template is the output off state.

3. Increase

Generate the on/off delay time by increasing from the time base value at the specified step ($\Delta t < 99999s$).

Delay time of next state = delay time of current state + step value;

The default initial state of the group data generated by this template is the output off state.

4. Decline

Generate the on/off delay time by declining from the time base value at the specified step ($\Delta t < 99999s$).

The default initial state of the group data generated by this template is the output off state.

4.7 Save and Read the Timer/Delay File

Users can store the timer/delay parameters edited manually or using the template in internal or external memory and recall them when required.

Save

The instrument can store 10 groups of setting values of the three functions of list mode, delayer and state file respectively, and also supports external storage.

Press  to enter the state storage interface. The storage contents include the present setting values of voltage and current of each channel, overvoltage and overcurrent values, the setting values of triggers and monitors, upper computer connection baud rate and IP address, etc.:

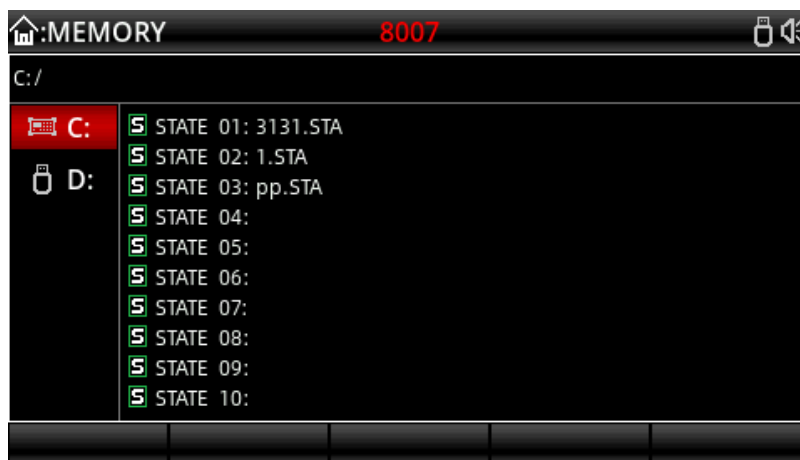

State file storage interface (the file suffix is STA)

After entering the list mode function, press "storage" to save/read.

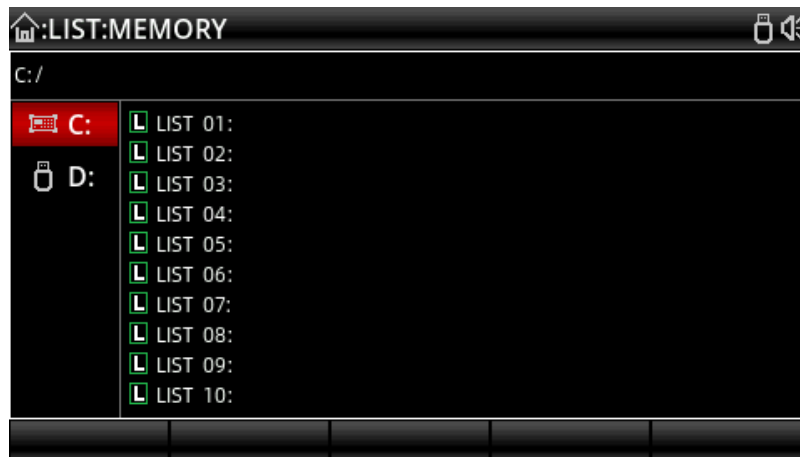

List mode storage interface (the file suffix is LIST)

After entering the delayer function, press "storage" to save/read.

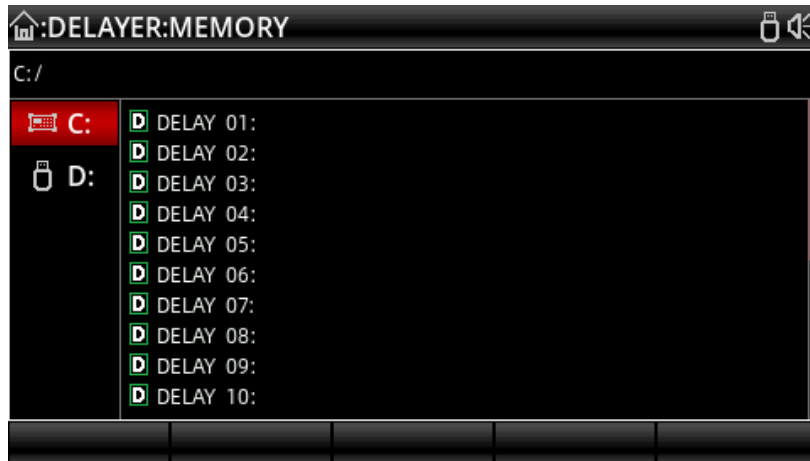

Delayer storage interface (the file suffix is DLY)

Save and select name files by using the knob. The suffix of a list mode file is .LST, and the suffix of a delayer file is .DLY. The files can also be saved on an external storage medium, such as a U disk.

4.8 Read

Turn on the list mode/delayer function, and press "Storage" to enter the storage interface.

Press the knob to select the parameter group file to be recalled. After pressing the "Read" key, the screen displays "Load succeeded".

Press the "ESC" key twice to return to the initial interface of list mode/delayer.

Press the "Enable" key to read the stored files.



File read interface

4.9 Waveform Display

UDP3305S series power supply has waveform display function, which can display the output voltage, current and power of each channel on the screen.

When each channel operates independently, voltage, current and power waveforms of three channels can be displayed on the screen at the same time. When CH1 and CH2 are in series/parallel mode, only the waveforms of

CH3 and series/parallel channel can be displayed simultaneously. To view the output waveforms of the list mode and delayer, set and enable the list mode and delayer functions first, and then turn on the waveform display function.

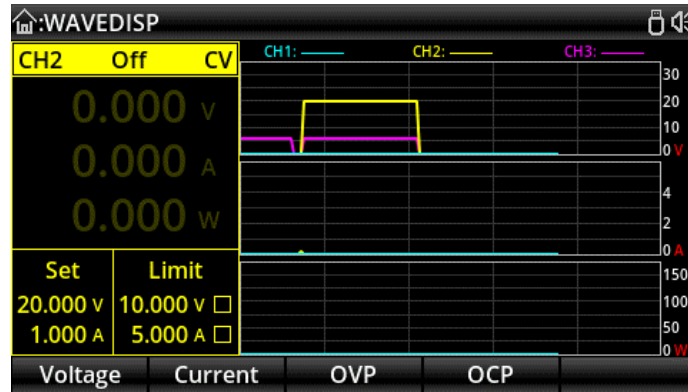

Operation steps:

1. Press the power switch to power on the instrument.
2. Turn on the waveform display function:
Press 3 to enter the waveform display interface.
3. Select the channel:
Select the channel according to the load and connect the load (refer to chapter "Constant Voltage Output", "Constant Current Output", "Power Supply Series and Parallel Connections"), set the voltage, current, over voltage and over current protection values.
For list mode and delayer waveforms, refer to chapter "List Mode (Timer) and Delayer".
4. View the waveform:
Turn on the selected output channel to view the waveform.
To view the list mode and delayer waveforms, press again.

4.10 Preset

UDP3305S series power supply supports 5 sets of output presets that can be freely edited and stored. Users can set the voltage, current, limit voltage and limit current parameters of each channel and series and parallel channel in advance, and load the parameters when required.

PRESET	Preset1	Preset2	Preset3	Preset4	Preset5
		Volt(V)	Curr(A)	OVP(V)	OCP(A)
CH1	05.000	5.000	03.000 <input type="checkbox"/>	1.000 <input type="checkbox"/>	
CH2	00.000	0.000	03.000 <input type="checkbox"/>	1.000 <input type="checkbox"/>	
CH3	0.000	0.000	3.000 <input type="checkbox"/>	1.000 <input type="checkbox"/>	
SER	00.000	0.000	03.000 <input type="checkbox"/>	1.000 <input type="checkbox"/>	
PARA	05.000	10.000	03.000 <input type="checkbox"/>	01.000 <input type="checkbox"/>	
	Edit				Load



Preset interfere

Operation steps:

1. Press the power switch to power on the instrument.

2. Press  to enter the preset interface.

3. Select a preset group:

Rotate the knob or press  or  to switch between the preset groups. Press the Edit key or the knob to select a preset group and enter its editing interface.

4. Edit preset group parameters:

In the editing interface, rotate the knob to select the channel. Then edit the voltage, current, overvoltage and overcurrent values of each channel by pressing the keys at the bottom of the screen.

5. Load preset group parameters:

Press  or press the knob twice to exit the editing interface. Press the "Load" key, the interface automatically jumps back to the power on interface, and the parameters of each channel are displayed as the preset parameter values.

4.11 Monitor

The monitor function reads the voltage, current and power of each independent channel, series and parallel channel, and alert users of the output of each channel and determines whether to close the output according to the predefined conditions.

Operating mechanism:

When the monitored voltage, current and power is greater than or less than the set value, the output is automatically adjusted to the combination (or/and) of current, voltage and power. The alarm and prompt can be set. Each independent channel can be monitored at the same time. In series and parallel mode, the independent channel will stop monitoring, and only the CH3 channel can be monitored simultaneously.

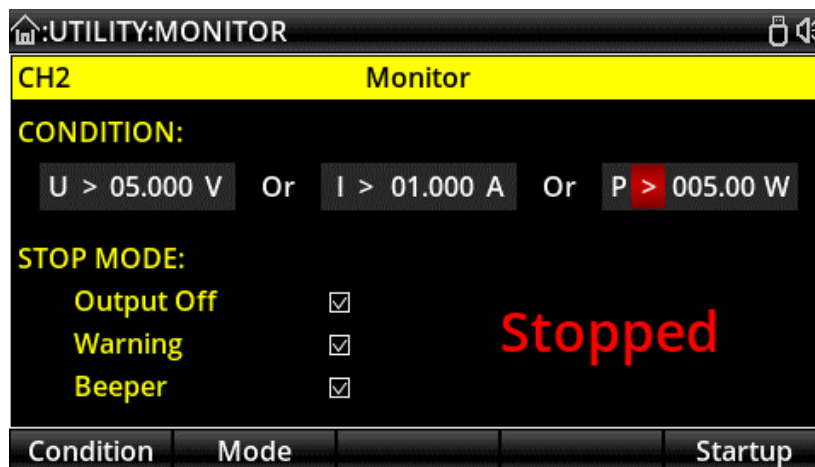

Operation steps:

1. Press the power switch to power on the instrument.

2. Enter the monitor interface:

Press , select "Monitor", and then press the "Enter" key or the knob to enter the monitor setting interface.

3. Select the monitor channel and set the parameters:

Select a channel and connect the load.

Set the monitoring conditions: voltage, current and power; > or <; combination (or/and) of current, voltage and power.

Set the monitor response mode: output off, warning, beeper.

4. Turn on the monitor:

Press the "Enable" key to turn on the monitor function.

4.12 Trigger

The trigger can be used as a trigger source to output high and low level signals to the external instrument, or as a source under control to trigger the on and off of the instrument output through the external input level.

When triggered by an external signal, the trigger operates in trigger input mode. When the digital I/O interface detects the trigger signal, the power supply controls the channel action. When the external instrument is triggered, the digital I/O interface outputs high or low level signals when the trigger conditions are met.

The digital I/O interface on the rear panel needs to be connected, and the high level of IO input should not be higher than 3.3V to avoid damage to the instrument.

Note: When the trigger operates in trigger input mode, D0~D3 is high level by default, and low level signal needs to be connected to trigger.

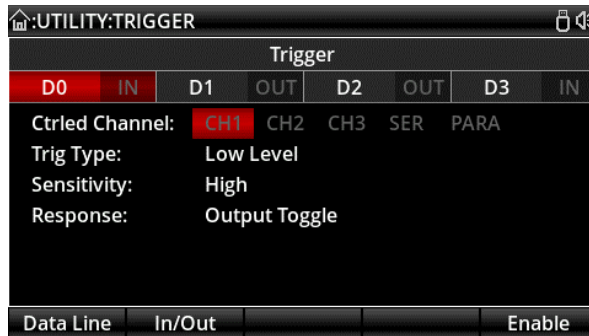

Trigger input

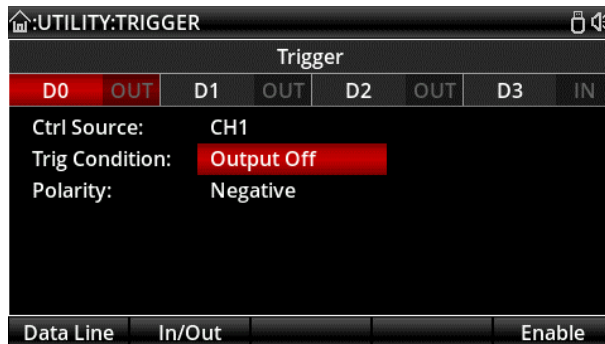



Trigger output

Operation steps:

1. Connect the digital I/O interface on the rear panel to the external trigger source.
2. Press the power switch to power on the instrument.
3. Enter the trigger interface:
Press , select "Trigger", and then press the "Enter" key or the knob to enter the trigger setting interface.
4. Select the trigger channel and set the parameters:
Press "Data line" to select D0, D1, D2 or D3.
Press "In/Out" to select trigger input or trigger output.

Trigger Input

Source under control: Press  or  to select one or more of CH1, CH2 and CH3 as the source under control.



Press the knob to confirm.

Trigger type: Press the "Left" or "Right" key and rotate the knob to select to trigger on the rising edge, falling edge, high level or low level of the input signal.

Sensitivity: Users can set the sensitivity to high, middle or low.

Response mode: Users can set the output response type to "Output on", "Output off" or "Output toggle".

Trigger Output

Control source: Press  or  to select any of CH1, CH2 and CH3 as the control source. Press the knob to confirm.

Trigger condition: Rotate the knob to select and set the trigger condition.

Polarity: Set the polarity of the trigger output signal to "Positive" or "Negative".

5. Enable:

Press Enable to enable the trigger function.

4.13 System Settings

In the system settings interface, users can view and modify system parameters, such as the IP address, baud rate of RS232 interface, current system software version, and screen brightness.



System settings interface

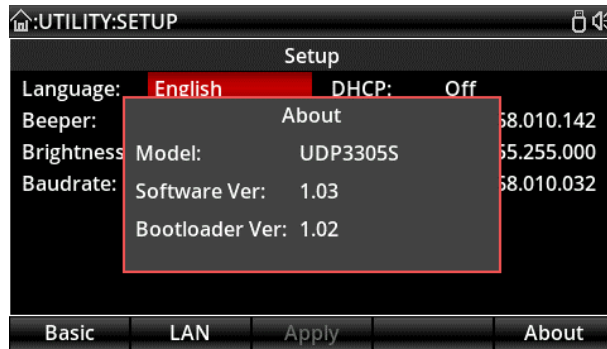

System software version

UNI-T®**UNI-TREND TECHNOLOGY (CHINA) CO., LTD.**

No. 6, Gong Ye Bei 1st Road,
Songshan Lake National High-Tech Industrial
Development Zone, Dongguan City,
Guangdong Province, China