

P/N:110401108231X



# UDP3000A Series Linear DC Power Supply User Manual

## Safety Information

Important safety instructions must be followed for operating and storing the UDP3000A series. To ensure your personal safety, read the following instructions carefully before operation to ensure that the UDP3000A series is in the best working environment.

## Safety Symbol

	Caution
	Danger! High Voltage
	Ground Terminal

## Safety Guidelines

- Do not block and isolate the air inlet and vent
- Avoid physical impact or using the instrument improperly
- Do not discharge static electricity onto the instrument
- Only professionals should open the instrument

## AC Input

- AC input voltage: 110V/120V/220V/230V, 50/60Hz
- Connect the protective ground wire to the earth to avoid shock hazard.

- Fuse Corresponding fuse type for the model:

Model	110V/120V	220V/230V
UDP3000A	T6. 3AL/250V (20X5mm)	T3. 15AL/250V (20X5mm)

- Make sure to use the correct fuse type before starting up
- To prevent fires, only replace with fuses that meet the model and rating value
- Do not connect the power cord before replacing the fuse to avoid electric shock
- Confirm the cause of the blown fuse before replacing the fuse

## Power Supply

AC input voltage includes 100V/120V/220V/230V ±10%, 50/60Hz. You can select different input voltages through the "AC SELECTOR" on the rear panel according to actual needs, please disconnect the power connection before switching the input voltage.

## UDP3000A Linear DC Power Supply Introduction

The UDP3000A DC power supply has three independent outputs: two of them are adjustable outputs of 30V/3A, the other one is a fixed selectable output of 1.8V/2.5V/3.3V/5V 3A. The device also has the constant voltage (CV) and constant current (CC) modes, short circuit and overvoltage protection features.

## UDP3000A Main Features:

- 4-digit voltage and current high precision display
- Overvoltage and overcurrent protection
- Output voltage/current settings can be viewed
- Remote control (output ON/OFF)
- Shutdown memory
- Software calibration
- Keypad lock
- Intelligent temperature-controlled fan
- USB phone charging interface

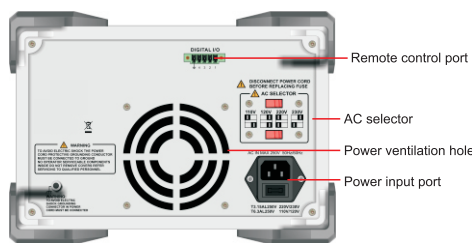
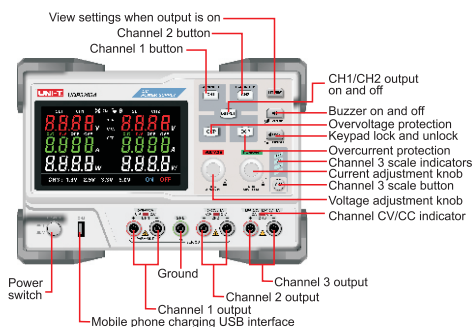

## Main Index Parameters

Test conditions: Turn on the device for 30 minutes at temperature +20°C ~ +30°C.

CH1/CH2	
Output Voltage	0-30V
Output Current	0-3A
Line Regulation	
Constant Voltage	≤0.01%+3mV
Constant Current	≤0.2%+3mA
Load Regulation	
Constant Voltage	≤0.01%+3mV (rated current ≤ 3A)
	≤0.02%+5mV (rated current > 3A)
Constant Current	≤0.2%+3mA
Resolution	
Voltage	10mV
Current	1mA
Programming Accuracy (25°C ± 5°C)	
Voltage	≤0.1%+30mV
Current	≤0.5%+2mA
Read Back Accuracy (25°C ± 5°C)	
Voltage	≤0.1%+30mV
Current	≤0.5%+2mA
Ripple and Noise (5Hz-1MHz)	
Voltage	≤1mVrms
Current	≤3mArms
Temperature Coefficient	
Voltage	≤300ppm
Current	≤300ppm
Parallel Mode	
Line Regulation	≤0.01%+3mV
Load Regulation	≤0.01%+3mV (rated current ≤3A)
	≤0.02%+5mV (rated current >3A)
Series Mode	
Line Regulation	≤0.01%+5mV
Load Regulation	≤300mV
Error	≤0.5%±10mV (10~30V no-load)
	(access load ≤300mV)
	≤0.5%±30mV (0~9.99V no-load)
(access load ≤300mV)	
CH3	
Output Voltage	1.8V/2.5V/3.3V/5.0V ±8%
Output Current	3A
Line Regulation (25±5°C)	≤5mV
Load Regulation (25±5°C)	≤15mV
Ripple and Noise (5Hz-1MHz)	≤2mVrms

## Function Introduction

### 1. Voltage / Current Setting and Output

- 1.1 a. Press CH1 button, the cursor will flash on the CH1 voltage position, press the voltage knob to move the cursor and rotate the knob to adjust the voltage value.  
b. Press CH1 again, the cursor will flash on the CH1 current position, press the current knob to move the cursor and rotate the knob to adjust the current value.  
c. Press CH2 to set the CH2 voltage and current values with the same method above.
- 1.2 Press the OUTPUT button to enable CH1 and CH2 outputs.
- 1.3 The shutdown has a memory function. The last set value can be automatically restored when the device is started next time.

The operation and display interfaces are as follows:

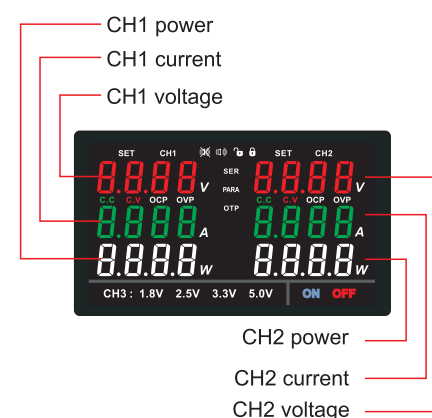
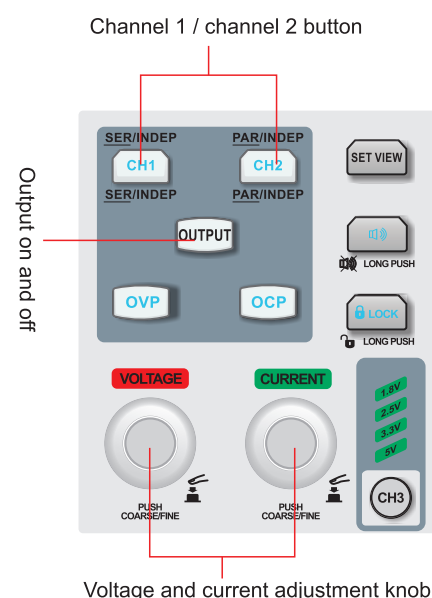

## 2. Series and Parallel Settings

### 2.1 Series Settings:

- 1 Press CH1 button for 3 seconds to enter series mode, the "SER" symbol will be on. CH1+ is the series positive output and CH2- is the negative output. The series voltage and current settings can only be adjusted in CH1, and the CH2 settings will follow that of CH1.
- 2 The series voltage total value is twice as much as CH1, and the current total value equals to CH1.

- ③ To exit the series mode, long press the CH1 button for 3 seconds, the "SER" symbol will disappear.
- ④ The shutdown has a memory function. The last voltage/current settings and the series mode will be restored when the device is restarted.

The serial output connection is as follows:

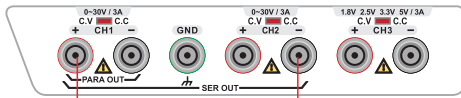

Series positive output    Series negative output

## 2.2 Parallel Settings:

- ① Press CH2 button for 3 seconds to enter parallel mode, the "PARA" symbol will be on. CH1+ is the parallel positive output and CH1- is the negative output. The parallel voltage and current settings can only be adjusted in CH1, and the CH2 settings will follow that of CH1.
- ② The parallel voltage total value equals to the CH1 voltage, and the current total value is twice as much as CH1.
- ③ To exit the parallel mode, long press the CH2 button for 3 seconds, the "PARA" symbol will disappear.
- ④ The shutdown has a memory function. The last voltage/current settings and the parallel mode will be restored when the device is restarted.

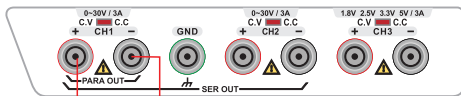

Parallel positive output    Parallel negative output

## 3. Constant Voltage / Constant Current

In constant voltage mode, the channel indicator will be green (CV). If the output current reaches the set value, device switches to the constant current mode.

In constant current mode, the channel indicator will be red (CC). If the output current is lower than the set value, device switches to the constant voltage mode.

The channel indicators are shown below:

Channel 1 indicator    Channel 2 indicator    Channel 3 indicator

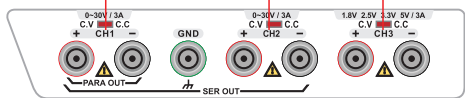

## 4. OVP (overvoltage protection), OCP (overcurrent protection) Setting and Enabling

- 4.1 Long press OVP button (>3s) to enter OVP threshold setting, press CH1 or CH2 to select the channel, then rotate the voltage knob to set the OVP limit, long press OVP button again to exit the OVP setting.

Short press OVP button (backlight on) to enable the overvoltage protection, if the output voltage exceeds the OVP set limit, the output will be shut off, and the OVP symbol will be on for a while. Short press OVP button again (backlight off) to disable overvoltage protection.

- 4.2 Long press OCP button (>3s) to enter OCP threshold setting, press CH1 or CH2 to select the channel, then rotate the current knob to set the OCP limit, long press OCP button again to exit the OCP setting.

Short press OCP button (backlight on) to enable the overcurrent protection, if the output current exceeds the OCP set upper limit, the output will be shut off, and the OCP symbol will be on for a while. Short press OCP button again (backlight off) to disable overcurrent protection.

## 5. Remote Control DIGITAL I/O Interface

To remotely control the output and shutoff of CH1/CH2, you can short-circuit or disconnect the pin 1 and 2 of the DIGITAL I/O terminal by a short-circuit wire or an external relay. The specific operations are as follows:

When the pin 1 and 2 of the DIGITAL I/O terminal are short-circuited, the OUTPUT button on the front panel is disabled, the power output is forcibly turned on, and the ON symbol appears on the LCD screen.

When the short circuit is released, the OUTPUT button function is restored, and the power output is turned off, the OFF symbol appears on the LCD.

The DIGITAL I/O port is shown in the following figure:

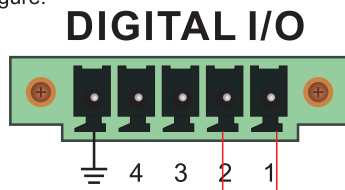

Remotely control power output by shorting or releasing PIN 1, 2.

## 6. CH3 Output

The CH3 has 4 sets of fixed outputs which are 1.8V/2.5V/3.3V/5.0V/3A, and it will select an output whenever the device is turned on. By pressing the CH3 button, the output voltage can be switched between 1.8V/2.5V/3.3V/5.0V and the corresponding indicator will be on.

The shutdown has a memory function. The last set value will be restored when the device is started up next time.

The CH3 operation and display interfaces are as follows:

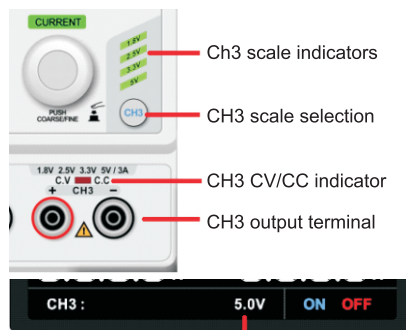

The CH3 selected voltage scale is lit on LCD

## 7. USB Interface Function

This interface is not for communication. It is only connected in parallel with CH3.

When charging for the mobile phone, please first switch CH3 to 5V scale, and then insert the USB cable.

## 8. OTP (over-temperature protection) Overview

Inside the power supply, there are two thermistors placed on the heat sink which has the maximum heat.

Once the power supply fails and the temperature of the heat sink reaches about 100°C, the over-temperature protection is triggered, and the output is turned off with the "OTP" symbol flashing on the LCD screen and periodical beeps.

The "OTP" symbol disappears when any key is pressed.

## 9. SET VIEW Introduction

When the power output is on, the voltage and current displayed on the LCD are the real-time sampling output values.

Press SET VIEW button (backlight on) to view the voltage and current set values.

Press SET VIEW button again (backlight off), the LCD redisplay the real-time sampling output voltage and current.

## 10. Buzzer On and Off

Press the BEEP button (backlight on), the buzzer will be on; long press the BEEP button (3s), the buzzer will be off.

The shutdown has a memory function. The last saved settings can be restored when the device is started up next time.

When the buzzer is enabled, it beeps for example:

- Power on/off
- CH1/CH2 setting switching
- Independent - series - parallel switching
- Output on/off
- OVP/OCP setup and on/off
- Pressing down the voltage/current knob
- SET VIEW (setting/output) display switching
- LOCK/UNLOCK operation
- CH3 output selection

## 11. Keypad Lock

Short press the LOCK button, the button backlight is on and the panel keypads are locked.

Long press the LOCK button (>3s), the button light is off and the keypads are unlocked.

## 12. Limited warranty and Liability

Uni-Trend guarantees that the product is free from any defect in material and workmanship within 3 years from the purchase date. This warranty does not apply to damages caused by accident, negligence, misuse, modification, contamination or improper handling. The dealer shall not be titled to give any other warranty on behalf of Uni-Trend. If you need warranty service within the warranty period, please contact your seller directly.

Uni-Trend will not be responsible for any special, indirect, incidental or subsequent damage or loss caused by using this device.

**UNI-T**  
UNI-TREND TECHNOLOGY (CHINA) CO., LTD.