

# UNI-T®



## UT171A/B/C

### Operating Manual



**Industrial True RMS  
Digital Multimeter**



PN: 110401105279X  
MAY.2018 REV. 1

## UT171A/B/C Instructions

### CONTENTS

I .Overview-----	1
II. Accessories-----	1
III. Safety Operation Criterion-----	2
IV. Electrical Symbols-----	3
V. Comprehensive Specification-----	3
VI. Appearance Structure -----	5
VII. Displayer -----	6
VIII. Knob of Function Selection and Button-----	8
IX. Measuring Operation Instructions-----	12
X .Technical Indexes-----	28
XI. Maintenance and Repair-----	35

## UT171A/B/C Instructions

**I. Overview**

UT171A/B/C DMM is a small-size handheld new automatic-ranging series of digital multimeter in 4 3/4-4 5/6 digit true virtual value which is complete in functions, high in quality and reliability, fashionable in structure, safe and displays with jumbo screen. It is applicable to measure AC/DC voltage/current, resistance, diode, circuit on-off, capacitance, frequency, duty ratio, centigrade/ Fahrenheit, % (4-20mA), conductivity, voltage to frequency converter (V.F.C), NCV non-contact AC voltage sensing, and it is also equipped with such functions as 600A AC/DC current calipers measurement, square-wave output, data storage, misoperation alarm, USB/Bluetooth interface configuration, etc. It is a necessary portable instrument for users in design, research and repair.

**II. Accessories**

Open packing box and take out the instrument. Please carefully check whether or not the following accessories are missing or damaged. Please contact your supplier in case of any missing or damage.

- |   |           |
|---|-----------|
| 1. Operation Instruction-----   | one copy  |
| 2. Probe-----   | one pair  |
| 3. Point K-type(nickel-chromium↔nickel-silicon)thermocouple(configured for UT171B/C only)---- | one piece |
| 4. Lithium battery charger (configured for UT171B/C only)-----                                | one piece |
| 5. USB cable-----   | one piece |
| 6. Bluetooth interface-----   | optional  |
| 7. Current calipers(UT171C only)-----   | optional  |

## UT171A/B/C Instructions

**III. Safety Operation Criterion**

UT171A/B/C design meets the safety standards of IEC/EN61010-1, pollution level 2, overvoltage category (CAT III 1000V and CAT IV600V) and double insulation. Please observe the following operation instruction, otherwise, the instrument provided protection is likely to be damaged.

Conforms to UL STD. 61010-1, 61010-2-030, 61010-2-033 Certified to CSA STD. C22.2 NO. 61010-1, 61010-2-030, IEC STD 61010-2-033

CAT III: Applicable to test and measuring circuits connected to the distribution part of the building's low-voltage MAINS installation, before use and follow all safety instructions.





CAT IV: Measurement category IV is for measurements performed at the source of the low-voltage installation. Examples are electricity meters and measurements on primary overcurrent protection devices and ripple control units.

- Using without rear cover secured is prohibited, otherwise, shock hazard may occur!
- Before using, it is necessary to check the insulation layer of the probe which shall be kept intact without damage or broken line.
- When the symbol of "⚡" is displayed on the LCD, it is necessary to replace battery so as to assure the measuring precision.
- Function range switch must be placed at the correct measuring location.
- Signals detected are not allowed to exceed the limit value so as to prevent electric shock and instrument damage!
- Gears of range switch are not permitted to change during measuring so as to avoid instrument damage!
- After the measurement is completed for each time, it is necessary to disconnect probe from circuit under test; after current measuring is completed, it is necessary to cut off power supply and disconnect probe and circuit under test, which is more important for measuring of high current.

## UT171A/B/C Instructions

8. In case the voltage under test is higher than DC 30V or AC 30Vrms, it is necessary to be careful and prevent electric shock!
9. Do not use it at high temperature and humidity. In particular, do not store the instrument in a humid environment. Instrument moisturized is likely to deteriorate in performance.
10. Please do not change wiring inside the instrument at random to prevent instrument damage and insecurity!
11. As for maintenance, please use wet cloth and mild detergent to clean the instrument case. Do not use abrasant or solvent!
12. Use a test probe CATIV600,CATIII1000V or better which meet the requirements of IEC61010-31

### IV. Electrical Symbols

	Double insulation
	Warning
	Grounding
	Meet European Union instructions.
	This symbol signify the product comply with both USA and Canada requirement

### V. Comprehensive Specification

1. Overload protection voltage between input terminal and grounding shall be 1,000V
2. 10A terminal (CE): F 10A H 1,000V fast fuseΦ10x38mm
3. mA/μA terminal (CE): FF 800mA H 1000V fast fuseΦ6x32mm
4. Maximum display: (UT171A) 40,000, (UT171B/C) 60,000  
Capacitance: 4,000 (UT171A); 6,000 (UT171B/C)  
Frequency: 40,000 (UT171A); 60,000 counting (UT171B/C).

## UT171A/B/C Instructions

Duty ratio: 1-99.9%  
Diode: 0-3.0000V  
% (4-20mA): 0-100.0%  
Simulated pointer: (UT171A) 21 pointers and (UT171B/C) 31 pointers

### 5.Others:

- \* Range: automatic/manual
- \* Polarity: automatic
- \* Update 4-5 times per second (except for some functions). It will display "OL" in case of overrange.
- \* Operating temperature: 0°C-40°C
- \* Relative humidity: 0°C-30°C ≤75%, 30°C-40°C ≤50%
- \* Storage temperature: -10°C-50°C
- \* Operating altitude: 0-2,000m
- \* Battery in machine:  
UT171A: AAA 1.5V×6 batteries  
UT171B/C: lithium battery 7.4V/1,800mAh
- \* Low battery: LCD displays the symbol of "  "
- \* Displayer:  
UT171A: LCD UT171B: VT-WLCD UT171C: OLED
- \* Boundary dimensions: about (206 long x 95 wide x 53 high) mm
- \* Weight: UT171A is about 500g (including batteries)  
UT171B/C is about 500g (including batteries)
- \* Electromagnetic compatibility:  
In IV/m radio-frequency field: gross precision = specified precision + 5% of range. No specific index for radio-frequency field over 1V/m.
- \* Verification: CE ETL

## UT171A/B/C Instructions

### VI. Appearance Structure (Refer to Figure 1)

1	Shell	2	Displayer
3/4/7	Function key	5	Range knob switch
6	Input terminal for measuring	8	Alarm luminous diode
9	USB cable/Bluetooth interface/NCV sensing terminal		

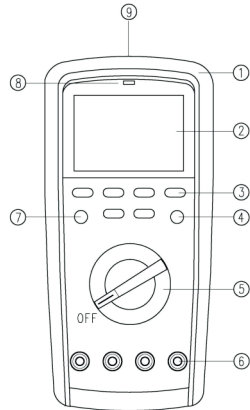
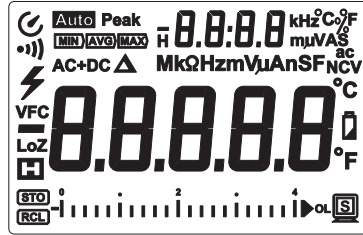
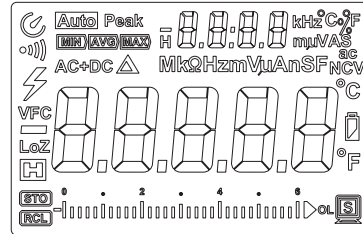

Figure 1



UT171A (positive display)



UT171B (negative display)

UT171C(The default TFT lattice)



Figure 2

## UT171A/B/C Instructions

### VII. Displayer (Refer to Figure 2)







No.	Symbol	Specification
1		Data recall
2		Data storage
3		Data hold
4	<b>LoZ</b>	AC low impedance
5	<b>-</b>	Negative value
6	<b>VFC</b>	Measuring of voltage to frequency converter
7		Alarm for high voltage
8		Circuit on-off measurement
9		Automatic shutdown
10	<b>Auto</b>	Automatic range
11	<b>Peak</b>	Peak measuring
12	<b>MIN/AVG/MAX</b>	Prompt for measuring minimum/average/maximum value
13	<b>AC/DC</b>	AC/DC measurement
14		Relative measuring
15	<b>mV, V</b>	Voltage unit: millivolt and volt
16	<b>μA, mA, A</b>	Current: microamp, milliampere and ampere

## UT171A/B/C Instructions

No.	Symbol	Specification
17	$\Omega, k\Omega, M\Omega$	Resistance unit: ohm, kilohm and megohm
18	$nF, \mu F, mF$	Capacitance unit: nanofarad, microfarad and millifarad
19	$Hz, kHz, MHz$	Frequency unit: Hz, kHz and MHz
20	$mS$	Period unit: millisecond
21	%	Duty ratio or % (4-20mA) measurement unit
22	<b>AC</b>	AC
23	<b>nS</b>	Conductivity unit: nano-siemens
24	<b>NCV</b>	Non-contact AC voltage sensing
25	$^{\circ}C/^{\circ}F$	Centigrade/Fahrenheit unit
26		Undervoltage of battery in the machine
27		Interface output
28	<b>-88888</b>	Measuring value for main displayer
29	<b>-8888</b>	Measuring value for auxiliary displayer
30	<b>XXXX</b>	Auxiliary displayer: storage No. and setting value
31	<b>H XX:XX</b>	Auxiliary displayer: hour XX: XX timing value
32		Simulated pointer

## UT171A/B/C Instructions

### VIII. Knob of Function Selection and Button

Location of Function Knob	Functional Description
<b>V~ V=</b>	AC/DC voltage measurement
<b>LoZ</b>	AC low impedance voltage measurement
$\Omega$	Resistance measurement
<b>nS</b>	Conductivity measurement
	Diode PN junction voltage measurement
	Circuit on-off measurement
	Capacitance measurement
<b>Hz</b>	Frequency measurement
<b>%</b>	Duty ratio measurement
<b>%(4-20mA)</b>	For measurement on (4-20mA) current transducer only
$^{\circ}C/^{\circ}F$	Temperature measurement
<b><math>\mu A \approx mA \approx 10A \approx</math></b>	AC/DC measurement
<b>AC+DC</b>	(AC + DC) measurement
<b>600A </b>	ACA/DCA current calipers measurement(UT171C only)
 <b>Output</b>	square-wave output measurement (UT171C only)
<b>NCV</b>	Non-contact AC voltage sensing
	Built-in lithium battery charging gear
<b>OFF</b>	Power supply is off in the machine

## UT171A/B/C Instructions

## Buttons:

- \*. RANGE button: click to switch over automatic→manual range. LCD displays “Auto” prompt disappears. One clicking results in one gear of range upwards. After reaching the highest gear of range, click to jump to the lowest gear of range. Circulate in sequence. Press the button for more than 2 seconds (including) or rotate for switchover and it will exit mode of manual range (applicable to  $V_{AC}$ ,  $\Omega$ ,  $I_{AC}$ , Freq Cap, and Loz only).
  - \*. STORE button: short press the button to save a piece of data and LCD flashes “ $\overline{STO}$ ”: long press the button to enter automatic storage setting menu. In automatic storage setting menu, when auxiliary displayer displays “SET.1”, (UT171C auxiliary show“SET:INTERVAL”) it shall be advised to set interval for automatic storage (1~240) in the unit of second. Short press HOLD button to exit setting. Short press SELECT button to enter next interface and auxiliary displayer displays “SET.2” (UT171C auxiliary show“SET:DURATION”), it shall be advised to set duration for automatic storage in the unit of minute. Short HOLD button to return to SET.1 (UT171C auxiliary show“SET:INTERVAL”) and short press SELECT button to start the function of automatic recording based on parameters set. In automatic recording, short press HOLD/Esc button to exit automatic storage.
- Caution: in automatic storage, it is necessary to short press HOLD button or turn the knob to any gear (non-OFF gear location) to exit the function of automatic storage. It is not allowed to turn to OFF gear without exiting the function of automatic storage so as to prevent data loss.
- \*. RECALL button: short press the button to enter recall mode and LCD displays “ $\overline{RCL}$ ” (UT171C show“VIEW”). In recall mode, auxiliary displayer displays No. for current data. Short press REL or HZ button to rapidly recall one piece of data forward or backward and long press REL or HZ button to rapidly location data required for recall forward or backward. Short press RANGE button and HOLD button to delete current data and exit recall mode respectively. If it is necessary to delete all the data, please select in system setting menu and execute DEL function. ( UT171C for “FORMAT” function).

## UT171A/B/C Instructions

## \*. MAX/AVG/MIN/Peak hold button:

Short press MAX MIN→enter the mode of manual range recording. The function of automatic shutdown is cancelled. LCD will display “ $\overline{MAX}$ ” and auxiliary displayer will display MAX; then click. LCD will display “ $\overline{AVG}$ ” and auxiliary displayer will display AVG; click again. LCD will display “ $\overline{MIN}$ ” and auxiliary displayer will display MIN; (the sequence is MAX/AVG/MIN); then long press MAX MIN to exit the mode of data recording.

In AC voltage/current functional state, long press “Peak hold” to enter the function of peak measurement. LCD will display “Peak”. Short press it to independently switch between P-Max and P-Min modes. Long press the “Peak hold” button to exit the function of peak measurement. And the response is about 1mS.

\*. HOLD/ :  button of data-hold/backlight:

HOLD→press the button and the displayed value will be locked and retained. LCD displays “ $\overline{H}$ ” prompt. Click once again and locking will be relieved, entering mode of general measuring.  →long press the button: turn off or on backlight (UT171A) and make fast switch among three kinds of backlight luminance (UT171B/C).

\*.  $\triangleleft$ /REL  $\triangle$  :button of direction selection/relative measurement:

REL  $\triangle$  →click to automatically enter the mode of manual range for relative measurement. Take current displayed value as reference value displayed on the auxiliary displayer. Then, make the difference between measured value and reference value display on the main displayer. Click again to re-select current original data as reference value. Long press the button to exit REL mode (applicable to  $V_{AC}$ ,  $\Omega$ ,  $I_{AC}$ , °C/°F and  $\overline{f}$  only).

## UT171A/B/C Instructions

\*. Hz%/▷/Setup: button of frequency, duty ratio/direction selection/setting:

Hz%→click to make frequency/duty ratio switch (applicable to: V~, I~, Hz/% only) Setup→long press the button to enter system setting menu. Main displayer setting item and auxiliary displayer setting parameters. Setting items include “brt” (BRIGHTNESS) for backlight, “Usb” (USB) for communication on/off, “bBEEP” (KEY BEEP) for buzzer switch on/off, “ALO” (ALO TIME) for automatic light off, “APO” (APO TIME) for automatic power supply off, “RTC DATE”for Date setting (UT171C only), “RTC TIME” for Time setting (UT171C only), “DEL” (FORMAT MEM) for memory formatting” . Short press the <◀ or ▶> button to select setting item. Short press HOLD button to exit setting menu. In the setting items, alter parameters of setting items through RANGE button or MAXMIN button. In the setting item of format memory, if parameter displayed on the auxiliary displayer is “YES”, operation of memory formatting will be executed by short pressing SELECT button and all the data saved will be cleared.

Caution: after setting parameters are altered, it is necessary to short press HOLD button or turn the knob to any gear (non-OFF gear location) to exit the function of setting menu. It is not allowed to turn to OFF gear without exiting setting menu so as to prevent loss of setting data.

\*. SELECT/ V.F.C.: button of selection/measurement on voltage or current to frequency conversion: SELECT→click to select function (applicable to complex function only).

V.F.C→in AC voltage mode, long press the button for 2 seconds or more and LCD will display “V.F.C”. It will be allowed to enter the mode of V.F.C measurement for stable measurement on voltage to frequency conversion. Long press the button for 2 seconds or more again and it will be allowed to exit the mode of V.F.C measurement:



SELECT→in mV gear, long press the button to enter or exit the function of temperature measurement (only applicable to UT171B/C);

SELECT→in mA gear, long press the button to enter or exit % (4-20mA) (only applicable to UT171B/C);

SELECT→in uA gear, long press the button to enter or exit square-wave function(UT171C only);

## UT171A/B/C Instructions

## IX. Measuring Operation Instructions

First of all, please check the built-in battery. When the instrument is on, in case of low battery, it will display the symbol of “” on the LCD, indicating that it is necessary to replace battery or charge in time before using. When instrument detects low power in battery, it will force itself to enter sleep mode. Besides, it is also necessary to notice the symbol of “” beside probe socket which warns you of not exceeding the indicated figure for voltage or current under test so as to ensure measuring safety!

## 1) Measuring AC/DC voltage (see Figure 3)

AC measuring displayed value is true virtual value. During in-circuit measurement, press Hz/% button to select the mode of measurement on frequency/duty ratio for auxiliary displayer. In the DC voltage function gear, press SELECT button to select mode of AC+DC measurement; press HZ/% button and auxiliary displayer will display AC/DC/HZ values orderly and “(AC+DC) value will be displayed on main displayer”. In low resistance LoZ: in AC gear, auxiliary displayer displays Hz or duty ratio (press Hz% button to switch)

 Caution:

- \*. Input impedance of instrument is higher, which is about 10MΩ. The load will cause error in measurement in high-impedance circuit. Mostly, if circuit impedance is lower than 10k, error can be ignored (0.1% or lower).
- \*. Do not input voltage higher than 1,000Vrms. It is accessible to measure higher voltage. However, it is likely to damage the instrument!
- \*. In measuring of high voltage, it is necessary to prevent electric shock hazard in particular!
- \*. To test the known voltage before use to confirm the product function is correct.



## UT171A/B/C Instructions

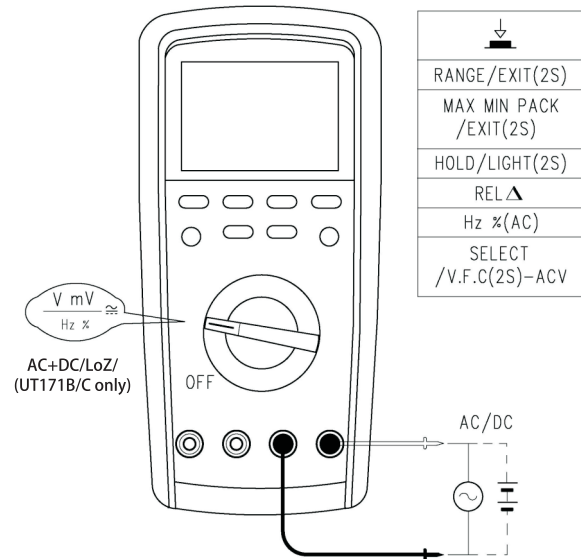

Figure 3

## UT171A/B/C Instructions

**2) Measuring of resistance/conductivity G (Figure 4a)**

- \* When measuring ultra-high resistance higher than 40MΩ, it is advised to use nS range to measure its conductivity G:  $G=1/R$  (Ω). The unit is Siemens(S)= $10^9/R$  (Ω). The unit is (nS).
- \* By virtue of function of resistance measuring, it is allowed to make self-check on built-in fuse. Refer to (Figure 4b).
- \* Open-circuit voltage is about 1V.

**⚠ Caution:**

- \* If the resistance under test is in open circuit or resistance is beyond maximum range of instrument, it shall display "OL" on LCD.
- \* In measuring in-circuit resistance, it is necessary to shut off all the power supply in the circuit under test and discharge the residual electric charge in capacitor before measuring so as to guarantee correct measuring.
- \* In low-resistance measuring, the probe will result in an error of 0.1Ω-0.2Ω in resistance measuring. In order to acquire accurate reading, it is necessary to short-circuit the probe and adopt REL relative measuring mode so as to ensure measuring precision.
- \* If probe resistance is higher than 0.5Ω in short circuit, it shall be necessary to check whether the probe is loose or of any other reason.
- \* While measuring high resistance, it is likely to take second time before reading is stable, which is normal for measuring high resistance.
- \* It is not allowed to input voltage higher than DC 30V or AC 30V so as to prevent personal injury!

## UT171A/B/C Instructions

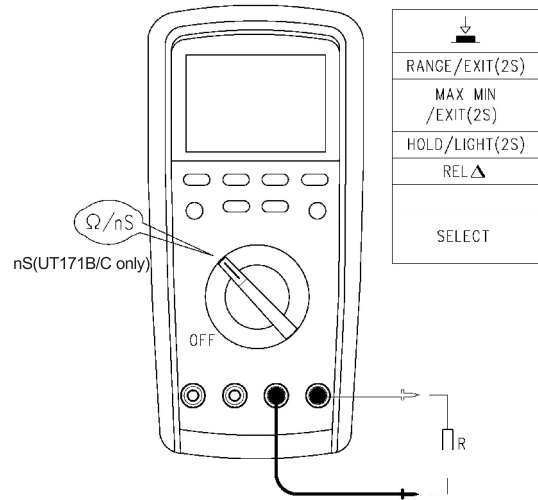

Figure 4a

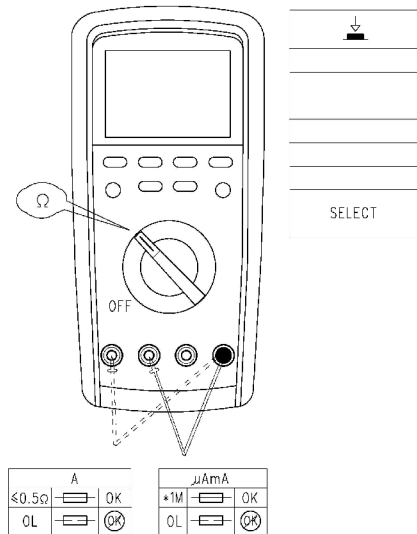

Figure 4b

## UT171A/B/C Instructions

### 3. Measuring of circuit switching (see Figure 5)

If resistance between two terminals measured is higher than 100Ω, it shall be deemed as open circuit and buzzer shall be without sound; if resistance between two terminals measured is lower than 10Ω, it shall be deemed as sound conductivity of circuit and buzzer shall produce constant sound.

#### ⚠ Caution:

- \* While inspecting in-circuit circuit switching, it is necessary to cut off all the power supply in the circuit under test and discharge residual electric charge in capacitor before measuring.
- \* Do not input voltage higher than DC 30V or AC 30V to prevent personal injury!

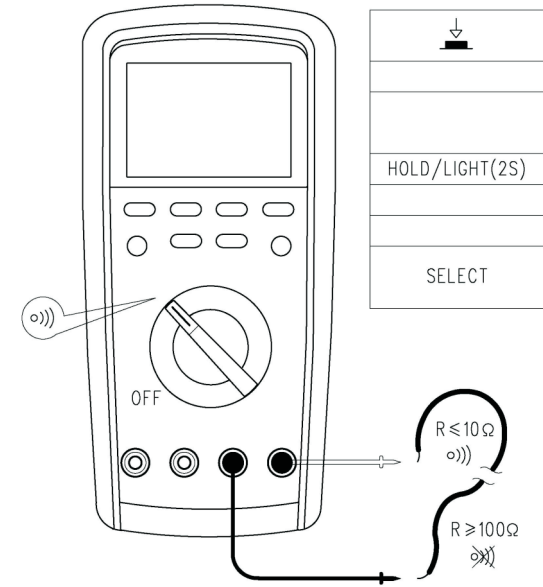

Figure 5

## UT171A/B/C Instructions

**4. Diode test (see Figure 6)**

Range of test voltage for diode is about 0-3V. Auxiliary displayer displays: "diod".

**⚠ Caution:**

- \*. If diode under test is in open circuit or reverse polarity, it will display "OL". In terms of silicon PN junction, 500-800mV shall be generally confirmed as normal value.
- \*. When measuring in-circuit diode, it is necessary to cut off all the power supply in the circuit under test and discharge residual electric charge in capacitor before measuring.
- \*. Do not input voltage higher than DC 30V or AC 30V so as to prevent personal injury!

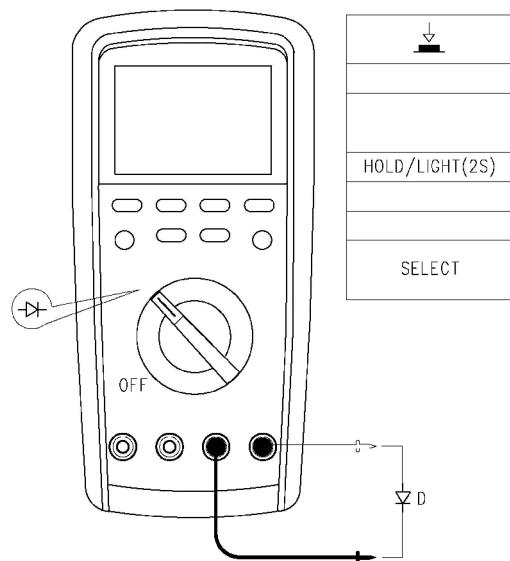

Figure 6

## UT171A/B/C Instructions

**5. Measuring of capacitance (see Figure 7)**

When there is no input, instrument will display fixed reading, which is the inherent capacitance of instrument. When measuring capacitance in small-range gear, the inherent value must be deducted from measured value to guarantee measuring precision. Therefore, it is allowed to utilize function of relative measuring REL of the instrument to make automatic deduction, facilitating measuring reading.

**⚠ Caution:**

- \*. If metered capacitance is in short circuit or capacitance is beyond maximum range of the instrument, LCD will display "OL".
- \*. As for measuring large bulk capacitance, it is normal to take seconds to measure.
- \*. Before testing, it is necessary to discharge all the residual electric charge in capacitance. It is particularly important for high-voltage capacitance, preventing damage on instrument and personal injury.
- \*. The measured capacitance if stored in a charge, may appear in the process of testing, the screen display DISCHARGE state

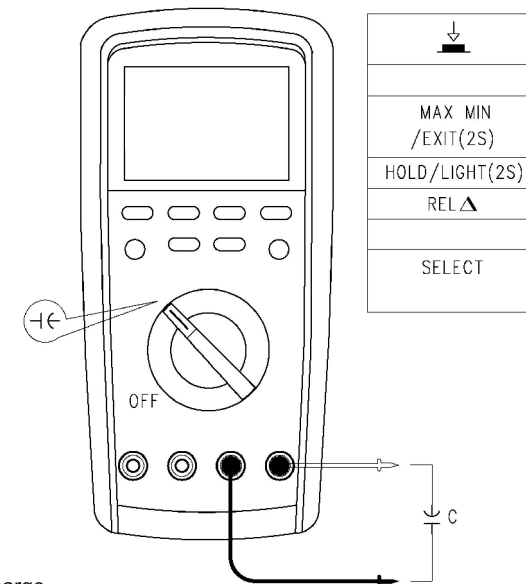

Figure 7

## UT171A/B/C Instructions

### 6. Measuring of frequency/duty ratio (see Figure 8)

In the gear of frequency measurement, press Hz/% button to select mode of period for auxiliary displayer/duty ratio measurement.

#### ⚠ Caution:

\*. Do not input voltage higher than DC 30V or AC 30V so as to prevent personal injury!

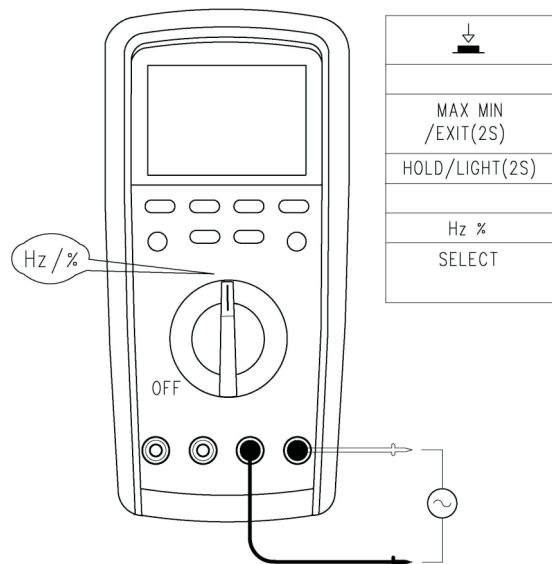

Figure 8

## UT171A/B/C Instructions

### 7. Measuring temperature (see Figure 9)

Long press SELECT in mV gear to enter or exit the temperature measurement function: short press SELECT under the temperature measurement function, to switch the display of °C (Celsius) and °F (Fahrenheit). Temperature sensor: applicable to K-type (nickel-chromium-nickel silicon) thermocouple only. Boot up to display "OL", and plug in K-type temperature sensor to meter °C or °F. (Applicable to UT171B/C only) °F=1.8°C+32

#### ⚠ Caution:

K-type (nickel-chromium-nickel silicon) thermocouple configured in accessories is applicable to measuring temperature below 230°C/446°F only!

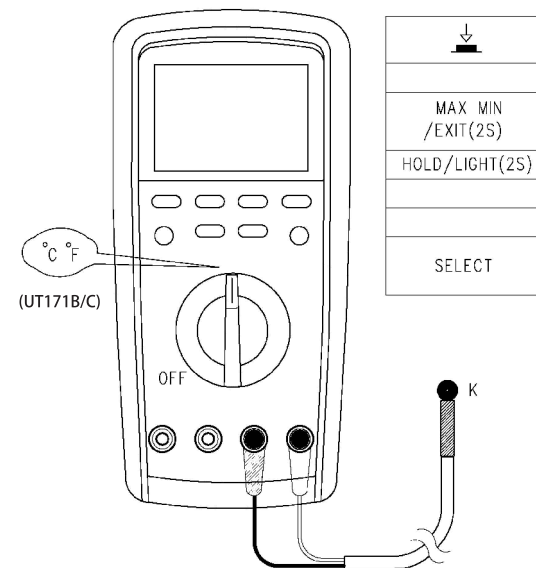

Figure 9

**8. Measuring AC/DC (see Figure 10)**

AC measuring displayed value shall be true virtual value.

\* When measuring online AC, click Hz/% button to select the auxiliary displayer frequency/duty ratio measuring mode. Press SELECT to select the AC + DC measuring mode: "(AC+DC) value will be displayed on main displayer". When clicking the Hz/% button, the status on the auxiliary displayer is AC component/DC component /frequency in sequence (UT171B/C only).

\* Long press SELECT in mA function range, to access % (4-20mA) measuring function, and the percentile calibration of measured current will be displayed: 4mA for 0%; 20 mA for 100% (applicable to UT171B/C only), see Figure 10.

**⚠ Note:**

- \* Before instrument is connected in series to the circuit to be tested, it is necessary to cut off power supply in the circuit.
- \* When measuring, it is necessary to use correct input terminal and function gear. In case of inability to estimate current magnitude, it shall be advised to start measuring from high-gear range.
- \* Fuse is set inside 10A and mA/  $\mu$ A input jack. Be sure not to parallel connect the probe test pin to any circuit, in particular, the power supply terminal, or it will damage instrument and endanger personal safety! When the metered current is higher than 5A, each measuring time shall be less than 10 seconds and interval shall be more than 15 minutes for the sake of safe utilization!

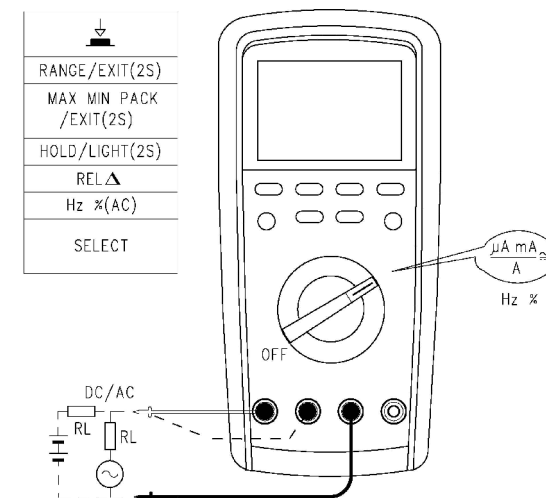

Figure 10

### 9. 60A/600A ACA/DCA External input current calipers measurement (see Figure 11)

Press RANGE button to change the 60A/600A measurement, SELECT button to select mode of the ACA/DCA function

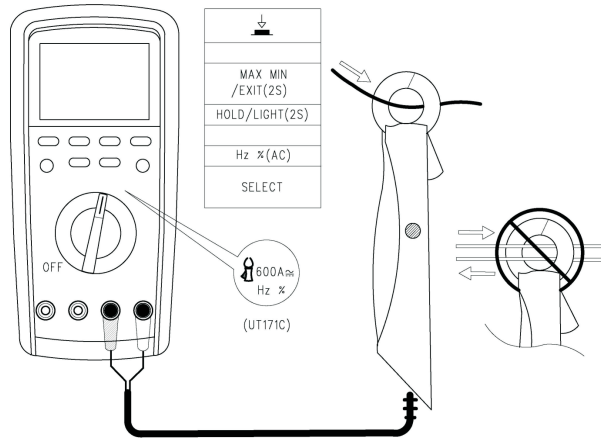

Figure 11

### 10. Non-contact AC voltage sensing (see Figure 12)

When checking whether the AC voltage or electromagnetic field exists in sensing space, it is advised to approach front end of instrument to the metered object for sensing detection. Analog capacity of sensing AC voltage is about: if it is lower than or equal to critical voltage V1, the main displayer will display "EF"; if it is higher than critical voltage V1, the main displayer will display transverse section of "-". Five sections of "-" are set based on section voltage Vd, with buzzing sound stimulated in different tempos so as to distinguish magnitude of sensing voltage. Besides, "red" light flashing is provided on top of the instrument.

#### ⚠ Caution:

When range switch is set at the gear of "NCV", no probe shall be required for sensing! If the electric field voltage is greater than 100 Vac, the instrument will let out acousto-optic prompts, (distance ≤ 10mm); if the distance is within 12mm-50mm, it is optional whether or not let out an acoustic prompt; if greater than 50mm, the sensing will not sound.

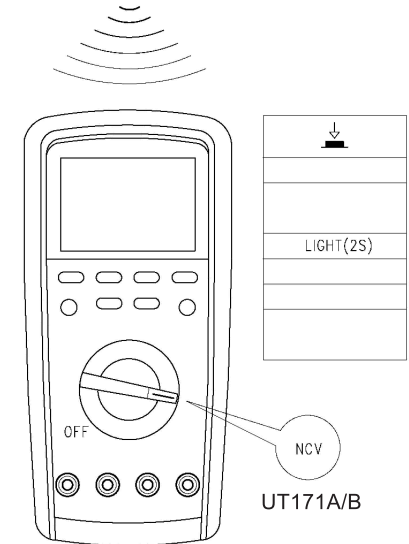

Figure 12

## UT171A/B/C Instructions

**11. Square-wave output (see Figure 13)**

Long press SELECT to enter or exit the square-wave output interface.

- \* Square-wave frequency output can be selected with RANGE and MAXMIN.
- \* Square-wave duty ratio % can be selected with (REL) (Hz%).
- \* Square-wave output amplitude is about 0.8Vp.
- \* Square-wave output cycle/duty ratio is 1%-100%.

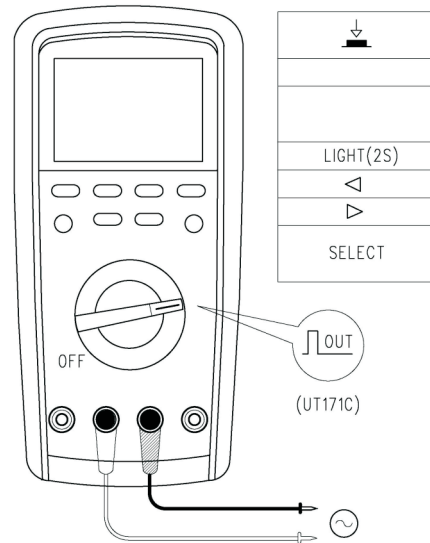

Figure 13

## UT171A/B/C Instructions

**12. Other functions:**

- \* After booting in full display for 2 seconds, it will enter normal measuring state. If an error or low voltage occurs to EEPROM inside the instrument, it will display "ErrE".
- \* Automatic shutdown  
If the knob switches and buttons are not operated within the set shut-down time (5-30 minutes), the instrument will "automatically shut down" to save energy. In the state of automatic shutdown, click any button or turn the knob switch, it will "automatically wake up". Since 1 minute before automatic shutdown countdown, the APO sign will flicker; if the "BEEP" is set as "ON", the buzzer will make 3 short "beep" warnings when counting down for 40, 20 and 10 seconds; it makes 1 "beep" warning in sleep mode. During the flicker of APO sign, short press any button to cancel the automatic shutdown (APO sign will reset to normal display), with no response to the original functions of buttons.  
In normal operation mode, access Setup menu to cancel the automatic shutdown function (APO TIME: OFF), and the characters of "APO" on the LCD screen disappears automatically.
- \* Buzzer:  
Press any button switch in the mode of BEEP ON, if the button with corresponding function works, the buzzer will make a sound of "Beep".  
In the normal operation mode, it makes a sound of "Beep" if the button operation is valid, and 2 consecutive "Beep" warnings if it's invalid.  
The beep of button is enabled or disabled in the Setup menu.  
If the probe is incorrectly inserted into the jacket, the buzzer will discontinuously sound indicating a warning.

## UT171A/B/C Instructions

**\* Low-voltage detection:**

If the internal VDD is lower than 7.3 V, under-voltage symbol of battery "⚡" will be displayed, indicating a requirement of battery replacement or charging for internal lithium battery (applicable to UT171B/C only) to ensure the measurement precision. If the low battery current is detected by the instrument, it will be forced into sleep mode.

**\* Charging internal lithium battery:** (see Figure 14) (applicable to UT171B/C only) connect the charging adapter provided for accessories in accordance with the figure, to charge the internal lithium battery. In the mode of charging, a red indicator alert will be emitted on top of the instrument, which turns green when the charging voltage reaches the full value, and then the instrument will automatically cut off the charging circuit as prompt for the completion of the charging.

**⚠ Caution:**

Upon the lead disconnection or failure of the lithium battery equipped in the instrument, consecutive red/ green light flashing will be emitted by indicator on the top (applicable to UT171B/C only).

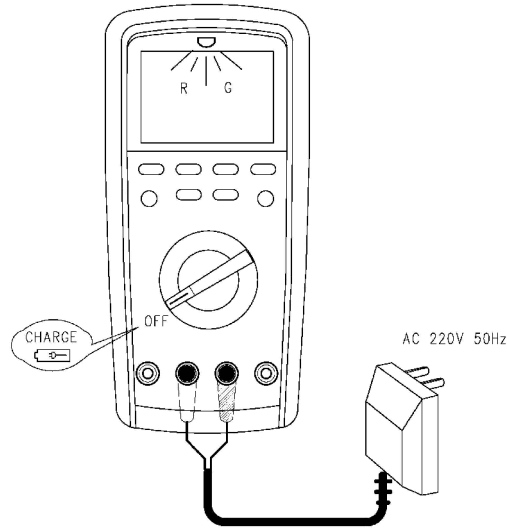

Figure 14

## UT171A/B/C Instructions

### X Technical Indexes

Accuracy:  $\pm (a\% \text{ of reading} + b \text{ counts})$ . Accuracy is guaranteed for 1 year. Ambient temperature:  $23^{\circ}\text{C} \pm 5^{\circ}\text{C}$  ( $73.4^{\circ}\text{F} \pm 9^{\circ}\text{F}$ ); relative humidity:  $\leq 75\%$

**⚠ Caution:**

\* For accuracy, the temperature condition shall be controlled within  $18^{\circ}\text{C} - 28^{\circ}\text{C}$ , while the fluctuation range of ambient temperature shall be stabilized within  $\pm 1^{\circ}\text{C}$ . If the temperature is lower than  $18^{\circ}\text{C}$  or greater than  $28^{\circ}\text{C}$ , the additional temperature coefficient error shall be  $0.1x (\text{specified accuracy}) / ^{\circ}\text{C}$

\* If the change of ambient temperature is within  $\pm 5^{\circ}\text{C}$ , the accuracy is applied after 2 hours; upon the completion of battery charging, the accuracy is also applied after 2 hours.

### 1. Measuring of DC voltage

Range		Resolution	Accuracy $\pm(a\% \text{ of reading} + b \text{ counts})$			
UT171A	UT171B/C		DC	Frequency Response	45Hz-1kHz	>1kz-20kHz
400.00mV*	600.00mV*	10 $\mu\text{V}$	$\pm(0.025\% + 5)$	AC+DC (UT171B/C)	$\pm(1.2\% + 40)$	$\pm(6.0\% + 40)$
4.0000V	6.0000V	100 $\mu\text{V}$				
40.000V	60.000V	1mV				
400.00V	600.00V	10mV	$\pm(0.03\% + 5)$	Undefined		
1000.0V	1000.0V	100mV	$\pm(0.03\% + 5)$			

**⚠ Input impedance:**

\* Range  $\geq 1\text{G}\Omega$ , input impedance for other ranges is 10M $\Omega$ . (For \*range, unstable digit may be displayed in open circuit, digits  $\leq \pm 5$  shall be stable after connecting up load).

\*AD+DC the specifications are defined for signal input > 10% of range



## UT171A/B/C Instructions

### 2. Measuring of AC voltage

Range		Resolution	Accuracy ±(a% of reading + b counts)			
UT171A	UT171B/C		45Hz-1kHz	>1kz-10kHz	>10kz-20kHz	>20kz-100kHz
400.00mV*	600.00mV*	10 μV	±(0.4%+40)	±(5.0%+40)	±(5.5%+40)	±(8.0%+40)
4.0000V	6.0000V	100 μV		±(1.2%+40)	±(3.0%+40)	±(8.0%+40)
40.000V	60.000V	1mV		±(1.2%+40)	±(3.0%+40)	±(6.0%+40)
400.00V	600.00V	10mV		±(3.0%+40)	Undefined	
1000.0V	1000.0V	100mV	±(0.6%+40)	±(3.5%+40)		
LoZ /1000~V		0.1V	±(2%+40)			
V.F.C 600V/1000V		0.01V/0.1V	±(4%+10) Frequency Response: 45 ~ 400Hz			

⚠ Input impedance: input impedance is about 10MΩ.

Display: true virtual value; range of accuracy guarantee: 10-100% of range (the 1000V range is 20~100%); it is allowed to have residual readings < 50 digits in short circuit.

AC wave peak factor: can reach 3.0 in full-range value (excluding 750V range which is 1.5 in full-range value)

Non-sinusoidal waveform: the accuracy shall be increased by 3.0% if the wave peak factor is within 1.0-2.0

The accuracy shall be increased by 5.0% if the wave peak factor is within 2.0-2.5

The accuracy shall be increased by 7.0% if the wave peak factor is within 2.5-3.0

## UT171A/B/C Instructions

### 3. Measuring of DC current

Range		Resolution	Accuracy ±(a% of reading + b counts)			
UT171A	UT171B/C		DC	Frequency Response	45Hz-1kHz	>1kHz-10kHz
400.00μA	600.00μA	0.01 μA	AC+DC (UT171B/C)	±(0.25%+20)	±(1.5%+20)	±(2.0%+40)
4000.0μA	6000.0μA	0.1 μA			±(1.5%+20)	±(2.0%+40)
40.000mA	60.000mA	1 μA			±(1.5%+20)	±(2.0%+40)
400.00mA	600.00mA	10 μA			±(1.5%+20)	±(3.0%+40)
4.0000A	6.0000A	100 μA			±(2.0%+20)	±(6.0%+40)
10.000A	10.000A	1mA			±(1.5%+10)	±(5.0%+10)
% (4-20mA)		0.01%	±(0.5%+2) (Applicable to UT171B/C only)			

\*AD+DC the specifications are defined for signal input > 10% of range

### 4. Measuring of AC current

Range		Resolution	Accuracy ±(a% of reading + b counts)		
UT171A	UT171B/C		45Hz-1kHz	>1kz-20kHz	>20kz-100kHz
400.00μA	600.00μA	0.01 μA	±(0.75%+20)	±(1.2%+40)	±(6.0%+40)
4000.0μA	6000.0μA	0.1 μA	±(0.75%+20)	±(1.2%+40)	±(3.0%+40)
40.000mA	60.000mA	1 μA	±(0.75%+20)	±(1.2%+40)	±(9.0%+40)
400.00mA	600.00mA	10 μA	±(0.75%+20)	±(1.5%+10)	±(4.0%+40)
4.0000A	6.0000A	100 μA	±(1.5%+20)	±(6.0%+40)	Undefined
10.000A	10.000A	1mA	±(1.5%+5)	±(5.0%+10)	

## UT171A/B/C Instructions

Display: true virtual value; range of accuracy guarantee: 10-100% of range; it is allowed to have residual readings < 50 digits in short circuit.

AC wave peak factor: can reach 3.0 in full-range value

Non-sinusoidal waveform: the accuracy shall be increased by 3.0% if the wave peak factor is within 1.0-2.0

The accuracy shall be increased by 5.0% if the wave peak factor is within 2.0-2.5

The accuracy shall be increased by 7.0% if the wave peak factor is within 2.5-3.0

### 5. Measuring of resistance/ conductance (applicable to UT171B/C only)

Range		Resolution	Accuracy $\pm(a\% \text{ of reading} + b \text{ counts})$
UT171A	UT171B/C		
400.00 $\Omega$	600.00 $\Omega$	0.01 $\Omega$	$\pm(0.05\% + 10)$
4.0000k $\Omega$	6.0000k $\Omega$	0.1 $\Omega$	$\pm(0.05\% + 2)$
40.000k $\Omega$	60.000k $\Omega$	1 $\Omega$	$\pm(0.05\% + 2)$
400.00k $\Omega$	600.00k $\Omega$	10 $\Omega$	$\pm(0.05\% + 2)$
4.0000M $\Omega$	6.0000M $\Omega$	100 $\Omega$	$\pm(0.15\% + 5)$
40.000M $\Omega$	60.000M $\Omega$	1k $\Omega$	$\pm(3\% + 2)$
	60.00nS	0.01nS	$\pm(1\% + 10)$

## UT171A/B/C Instructions

### 6. Measuring of capacitance

Range		Resolution	Accuracy $\pm(a\% \text{ of reading} + b \text{ counts})$
UT171A	UT171B/C		
4.000nF	6.000nF	1pF	$\pm(3.0\% + 30)$
40.00nF~400.0 $\mu$ F	60.00nF~600.0 $\mu$ F	10pF~100nF	$\pm(2.5\% + 5)$
4.000mF~40.00mF	6.000mF~60.00mF	1 $\mu$ F~10 $\mu$ F	$\pm 10\%$

### 7. Measuring of frequency/duty ratio/cycle

Range	Resolution	Accuracy $\pm(a\% \text{ of reading} + b \text{ counts})$
60.000Hz~10.000MHz	0.001Hz~0.001MHz	$\pm(0.01\% + 5)$
1.0%~99.0%	0.1%	$\pm(3.0\% + 40)$
100.0mS~0.100 $\mu$ S	0.1mS~0.001 $\mu$ S	$\pm(0.1\% + 5)$

1) Input range a:

$\leq 100\text{kHz}$ : 500mVrms  $\leq a \leq 30\text{Vrms}$

$> 100\text{kHz}$ -1MHz: 600mVrms  $\leq a \leq 30\text{Vrms}$

$> 1\text{MHz}$ : 1Vrms  $\leq a \leq 30\text{Vrms}$

2) Duty ratio % is applicable to measuring  $\leq 100\text{kHz}$  only

3) During AC voltage or AC current measuring, when frequency or duty ratio is required to be read online, the following requirements must be met:

a. frequency response:  $\leq 100\text{kHz}$

## UT171A/B/C Instructions

- b. AC voltage: input range for 400.00mV or 600mV  $\geq$  range $\times$ 10%  
 input range for 4.0000V/ 40.000V/ 400.00V  $\geq$  range $\times$ 10%  
 input range for 6.0000V/ 60.000V/ 600.00V  $\geq$  range $\times$ 10%  
 input range for 1000.0V  $\geq$  range $\times$ 30%
- c. AC current: input range for 4000.0 $\mu$ A/ 400.00mA  $\geq$  range $\times$ 10%  
 input range for 400.00 $\mu$ A/ 40.000mA/ 4.0000A  $\geq$  range $\times$ 10%  
 input range for 6000.0 $\mu$ A/ 600.00mA  $\geq$  range $\times$ 10%  
 input range for 600.00 $\mu$ A/ 60.000mA/ 6.0000A  $\geq$  range $\times$ 10%  
 input range for 10.000A  $\geq$  range $\times$ 30%

### 8. Measuring of temperature (applicable to UT171B/C only)

Range		Resolution	Accuracy
°C	-40~1000°C	0.1°C	-40~0°C $\pm(2\%+3^\circ\text{C})$
			>0~100°C $\pm(1.0\%+3^\circ\text{C})$
			>100~1000°C $\pm(2.5\%)$
°F	-40~1832°F	0.1°F	-40~32°F $\pm(2.5\%+5^\circ\text{F})$
			>32~212°F $\pm(1.5\%+5^\circ\text{F})$
			>212~1832°F $\pm(2.5\%+5^\circ\text{F})$

**⚠ Caution:**

Point K-type (nickel-chromium-nickel silicon) thermocouple configured in accessory is applicable to measuring temperature below 230°C/446°F only!

## UT171A/B/C Instructions

### 9. Measuring with current caliper (UT171C only)

Range	Resolution	Accuracy $\pm(a\%$ of reading + b counts)
60A/600A DC	0.001A/0.01A	$\pm(1.0\%+30)$
60A/600A AC	0.001A/0.01A	$\pm(1.2\%+30)$

**⚠ Caution:**

\* When the outer caliper head is used for current measuring, the corresponding relationship between its input range and adaptive conversion ratio is (60A; 10mV/A) or (600A; 1mV/A).

\* The frequency response range is not defined under ACA mode and it can be determined according to the frequency response of caliper.

\* These specifications are defined for signal input > 10% of range

### 10. Square-wave output(UT171C only)

Range	Resolution	Accuracy $\pm(a\%$ of reading + b counts)
Frequency	0.5Hz-4800Hz (0.1Hz is the stepping level)	$\pm(0.01\%+5)$
Duty ratio %	0%-100% (0.1% is the stepping level)	$\pm(0.5\%)$
Amplitude	about 0.8Vp	$\pm 0.2Vp$

**⚠ Caution:**

1) The maximum square-wave output impedance is 50 $\Omega$ .

2) The positive or negative pulse width during adjusting the duty ratio must be more than 50 $\mu$ s.

## XI. Maintenance and Repair

### ⚠ Warning:

Before opening rear cover of instrument, it is necessary to power off; the probe has been off input terminal and circuit under test.

#### 1. General maintenance and repair

- \* During maintenance, please use wet cloth and mild detergent to clean the shell of the instrument. Do not use abrasant or solvent.
- \* In case of abnormality in instrument, it shall be necessary to suspend for repair.
- \* If instrument is required for calibration or repair, it is advised to assign qualified professional maintenance personnel or specific maintenance department for repair.

#### 2. Replacement of battery or fuse tube (see Figure 15)

##### ⚠ Operating steps:

- \* Set power switch to "Off" position, to replace UT171 diagram, remove the probe from input jack and unload protective jacket.
- \* Unscrew a screw fixed on the support with a screwdriver, to remove the rear cover of battery and support, replace the used under-voltage battery (applicable to UT171A only) and blown fuse F1/F2.
- \* Upon the low voltage displayed on UT171B/C, connect the power adapter for charging (DC 10V, 500mA).

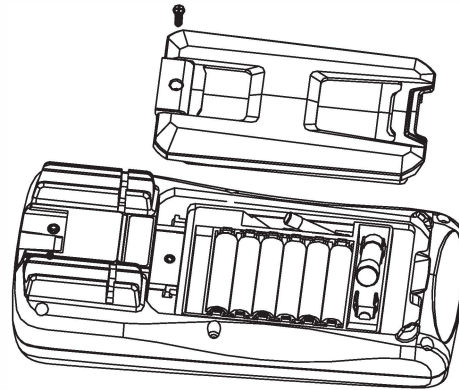

Figure 15

Instructions are subject to change without prior notice.