

UNI-T®

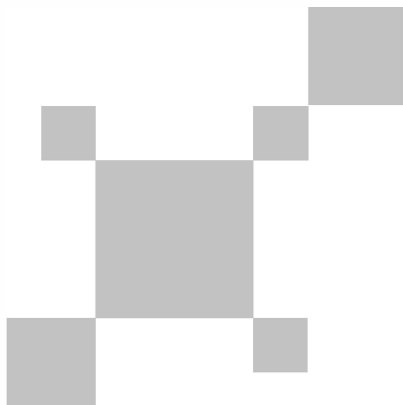

**UTx313/UT x318/UT x325
Thermal Monocular
User Manual**

P/N:110401111060X

PREFACE

Thank you for purchasing the new UTi384S thermal monocular. In order to use this product safely and correctly, please read this manual thoroughly, especially the Safety Instructions part.

After reading this manual, it is recommended to keep the manual at an easily accessible place, preferably close to the device, for future reference.

LIMITED WARRANTY AND LIABILITY

Uni-Trend guarantees that the product is free from any defect in material and workmanship within one year from the purchase date. This warranty does not apply to damages caused by accident, negligence, misuse, modification, contamination and improper handling. The dealer shall not be entitled to give any other warranty on behalf of Uni-Trend. If you need warranty service within the warranty period, please contact your seller directly.

This warranty is the only compensation you can obtain. Uni-Trend will not be responsible for any special, indirect, incidental or subsequent damage or loss caused by any reason or speculation. As some areas or countries do not allow limitations on implied warranties and incidental or subsequent damage, the above limitation of liability and stipulation may not apply to you.

TABLE OF CONTENTS

1. Technical Specifications	4
2. Product Appearance	5
2.1 Structure	5
2.2 Buttons	5
3. Basic Operations	6
3.1 Power on/off	6
3.2 Shutter Adjustment	6
3.3 Diopter Adjustment	6
3.4 Palette Switching	6
3.5 Image Zoom	6
3.6 Image Capture	7
4. Other Functions	7
4.1 Hot Trace	7
4.2 Laser/Center Point Mark	7
5. Settings	8
5.1 View Pic	8
5.2 Continuous Zoom	9
5.3 OSD Switch	9
5.4 Brightness	9
5.5 Contrast	9
5.6 Date	10
5.7 Time	10
5.8 DDE	10
5.9 Language	10
5.10 BG Adjust	11
5.11 APO Time	11
5.12 Video Export	12
5.13 Picture Mode	12
5.14 Product Info	12
6. Detection and Recognition	13
7. USB Communication	13
8. Charging	13
9. Safety Instructions	13
10. Packing List	13

1. Technical Specifications

Model	UTx313	UTx318	UTx325
Detector type	Uncooled vanadium oxide		
Detector resolution	384x288		
Response wave band	8-14μm		
Pixel size	12μm		
NETD	<40mK		
Lens focal length	13.5mm/F1.0	18mm/F1.0	25mm/F1.0
Field of view	20.3° (H) x15.2° (V)	14. 6° (H) x11° (V)	10.5° (H) x7.9° (V)
Frame rate	50Hz		
Focus	Manual		
Eyepiece	Monocular, adjustable diopter -5~+3		
Display size	0.4" LCOS		
Display resolution	1280*960		
Brightness	Adjustable		
Digital zoom	1X~4X		
Palettes	Black hot, white hot, hottest, iron, rainbow		
Digital detail enhancement (DDE)	Detail/edge		
Adjustment modes	Background/shutter/auto		
Image capture	√		
Hot trace	Real-time tracking of the highest temperature spot in the scene		
Memory	16GB		
Laser	650nm		
Battery type	Li-ion, 3.6V/4000mAh, 21700		
Charging time	≤4 hours		
Operating time	Continuous operating time>8 hours		
USB	Type-C interface, used for charging and data transmission		
Video export	MCX interface, export videos to the external monitor		
Operating temperature	-10 to +50°C		
Storage temperature	-40 to +70°C		
IP rating	IP67, 2m drop proof		
Certificates	UL, RoHS, CE		
Product size	207.6×62×62mm		
Product net weight	428g		

2. Product Appearance

2.1 Structure

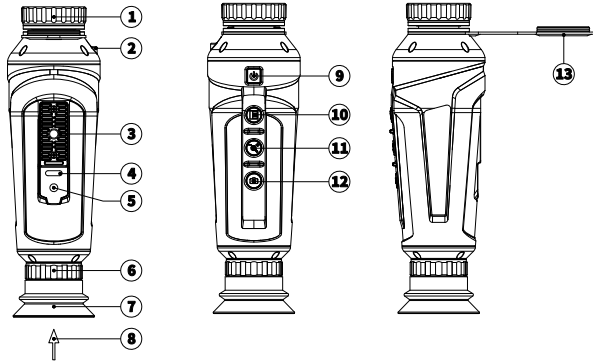

Item	Description	Item	Description
1	Objective lens and focus ring	8	Eyepiece
2	Laser	9	Power
3	Tripod screw	10	Palette
4	USB interface	11	Zoom
5	MCX interface	12	Capture
6	Diopter adjustment knob	13	Lens cover
7	Eyepiece cover		

2.2 Buttons

Buttons	Short press	Long press	Short press (in the setting interface)
Power	Shutter adjustment	Power on/off	
Palette	Palette switching	Enter the setting interface	Confirm/return (long press)
Zoom	1X, 2X, 4X	Hot trace	Up
Capture	Image capture	Laser	Down

3. Basic Operations

3.1 Power on/off

When the device is connected to USB cable or the battery is enough, long press the power button to power on. The indicator light will on and the time and battery status will show on the screen.

When the device is turned on, long press the power button to power off. The auto power off time can be set in the setting interface.

3.2 Shutter Adjustment

When the device is turned on, short press the power button, and the shutter will close for image correction.

Short press the power button again, the shutter adjustment will finish, the shutter will open automatically, and the device will continue operating normally.

When the image is abnormal, short press the Power button to manually call the shutter for image calibration.

At the same time, the shutter will close regularly to correct images automatically.

3.3 Diopter Adjustment

Rotate the adjustment knob to adjust the eyepiece diopter. When the image becomes clear, stop rotating the knob. This function is suitable for users of different vision to operate the device.

3.4 Palette Switching

When the device is turned on, short press the palette button to switch the palette. The current palette name will show at the bottom of the screen and disappear after 1s. The palette will switch between black hot, white hot, hottest, iron and rainbow.

The current palette will be automatically saved. The next time when the device is turned on, the last saved palette will be displayed.

3.5 Image Zoom

Short press the zoom button, the image will zoom, and the current magnification will show at the bottom of the screen. The magnification will switch between 1X, 2X and 4X.

The current magnification will not be automatically saved. The next time when the device is turned on, the magnification will be 1X.

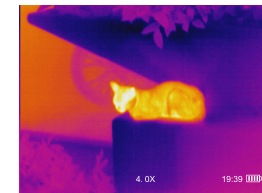
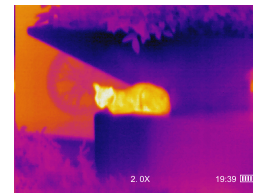

3.6 Image Capture

Short press the capture button to capture images. In manual mode, short press the capture button, and the current image will be frozen. Short press the capture button again to save the frozen image. When an image has been frozen, short press any button except the capture button to return to the main interface. In automatic mode, short press the capture button, the image will be automatically saved to the SD card.

Note: To ensure a rapid storage speed, if the device has saved 900 images, the remaining number of images that can be saved will show on the top of the screen. If the device has saved 1000 images, the remaining number of images will be 0, and the captured image cannot be saved. The saved images can be deleted when the device is connected to a computer. After deleting some images, the image storage function can continue performing.

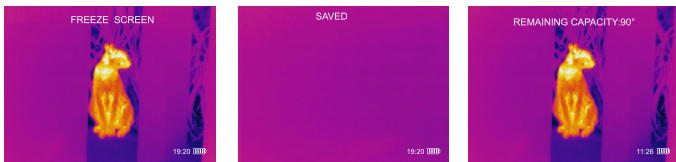

4. Other Functions

4.1 Hot Trace

In the main interface, long press the zoom button to turn on the hot trace function. A prompt will show on the bottom of the screen and disappear after 1s. A square icon will show on the screen, and the highest temperature spot in the scene will be tracked automatically. Long press the zoom button again to exit the function.

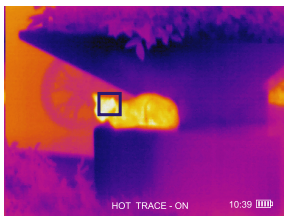

4.2 Laser/Center Point Mark

Long press the capture button to turn on the laser. The center point mark will show on the screen. Long press the button again to exit.

Note: There is a deviation between the center point and the laser point.

5. Settings

Long press the palette button to enter the setting interface. Short press the zoom/capture button to move the cursor up/down. Short press the palette button to enter the interface of the selected function or to confirm, and long press the palette button to exit/return to the previous page.

The setting items include: GALLERY, CONTINUE ZOOM, OSD SWITCH, BRIGHTNESS, CONTRAST, DATE, TIME, DDE, LANGUAGE, BG CALIBRATION, APO, VIDEO FORMAT, PHOTO MODE, PRODUCT INFO.

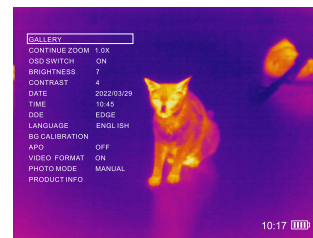
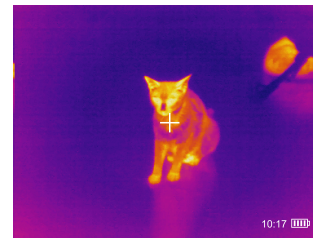

5.1 View Pic

Long press the palette button to enter the setting interface. Short press the zoom/capture button to move the cursor up/down and select "GALLERY". Short press the palette button to enter the picture viewing interface. The photo number will be displayed at the bottom of the screen.

Short press the palette button again to return to the photo directory. The photos can only be deleted on a computer. Long press the palette button to return to the main interface.

Note: On the device, users can view the latest 50 photos. On the computer, users can view all photos in the SD card.

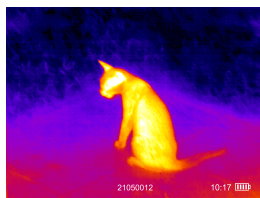
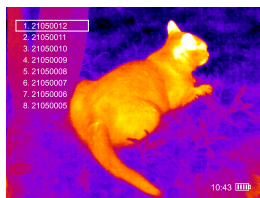

5.2 Continuous Zoom

Long press the palette button to enter the setting interface. Short press the zoom/capture button to move the cursor up/down and select "CONTINUE ZOOM". Short press the palette button to enter the continuous zoom interface. The magnification will show at the bottom of the display. Short press or long press the zoom button to zoom in (the maximum zoom is 4X). Short press or long press the capture button to zoom out (the minimum zoom is 1X).

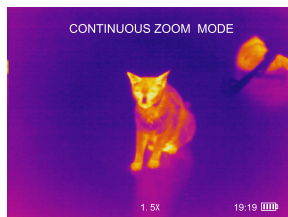

5.3 OSD Switch

Long press the palette button to enter the setting interface. Short press the zoom/capture button to move the cursor up/down and select "OSD SWITCH". Short press the palette button to set this function. Short press the zoom/capture button to select On/Off, and short press the palette button to confirm the selection. When the OSD switch function is on, the menu icon will be displayed. When the OSD switch function is off, the menu icon will be hidden.

5.4 Brightness

Long press the palette button to enter the setting interface. Short press the zoom/capture button to move the cursor up/down and select "BRIGHTNESS". Short press the palette button to set this function. Short press the zoom/capture button to adjust the brightness up/down (1-10 levels).

5.5 Contrast

Long press the palette button to enter the setting interface. Short press the zoom/capture button to move the cursor up/down and select "CONTRAST". Short press the palette button to set this function. Short press the zoom/capture button to adjust the contrast up/down (1-10 levels).

5.6 Date

Long press the palette button to enter the setting interface. Short press the zoom/capture button to move the cursor up/down and select "Date". Short press the palette button to set this function. Short press the palette button again to step through year/month/day. Short press or long press the zoom/capture button to adjust the date.

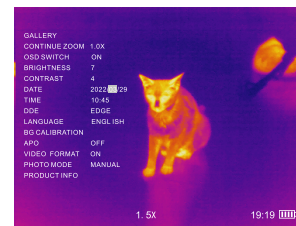

5.7 Time

Long press the palette button to enter the setting interface. Short press the zoom/capture button to move the cursor up/down and select "TIME". Short press the palette button to set this function. Short press the palette button again to step through hour/minute. Short press or long press the zoom/capture button to adjust the time.

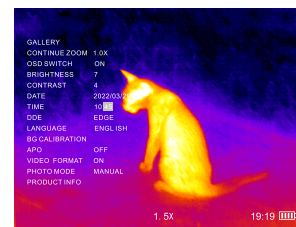

5.8 DDE

Long press the palette button to enter the setting interface. Short press the zoom/capture button to move the cursor up/down and select "DDE". Short press the palette button to set this function. Short press the zoom/capture button to select DETAIL/OFF/EDGE.

5.9 Language

Long press the palette button to enter the setting interface. Short press the zoom/capture button to move the cursor up/down and select "LANGUAGE". Short press the palette button to set this function. Short press the zoom/capture button to switch between Chinese/English, and short press the palette button to confirm.



5.10 BG Adjust

When there is a large difference between the device operating temperature and the environment background temperature, the image quality will be degraded. If the shutter adjustment is not useful at this time, the BG adjust function can be used.

Long press the palette button to enter the setting interface. Short press the zoom/capture button to move the cursor up/down and select "BG CALIBRATION". Short press the palette button to enter the BG adjust setting interface. A prompt "BG CALIBRATION, PLEASE COVER THE LENS" will show at the top of the screen. Short press the palette button to adjust.

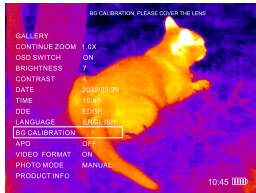

5.11 APO Time

Long press the palette button to enter the setting interface. Short press the zoom/capture button to move the cursor up/down and select "APO". Short press the palette button to set this function. Short press the zoom/capture button to set the auto power off time, including OFF (default)/5MIN/15MIN/30min/50MIN.

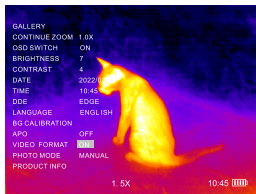

5.12 Video Export

Long press the palette button to enter the setting interface. Short press the zoom/capture button to move the cursor up/down and select "VIDEO FORMAT". Short press the palette button to set this function. Short press the zoom/capture button to select ON/OFF. When the video export function is turned on, analog video can be exported to an external monitor through the MCX interface.

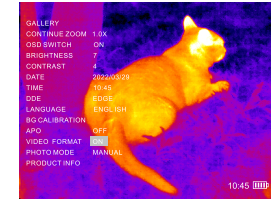

5.13 Photo Mode

Long press the palette button to enter the setting interface. Short press the zoom/capture button to move the cursor up/down and select "PHOTO MODE". Short press the palette button to set this function. Short press the zoom/capture button to select MANUAL/AUTO.

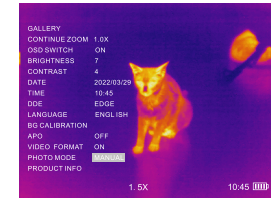

5.14 Product Info

Long press the palette button to enter the setting interface. Short press the zoom/capture button to move the cursor up/down and select "PRODUCT INFO". Short press the palette button to enter the product info interface. The product information will be displayed in the upper left corner. Press any button to exit.

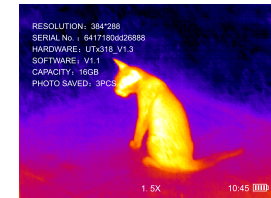

6. Detection and Recognition

Taking rabbits (0.35m), wild boars (0.7m) and human beings (1.7m) as examples, the following table shows the detection distance, recognition distance and identification distance of this thermal monocular.

	Recognition distance	Identification distance
Rabbits (0.35m)	87m	44m
Wild boars (0.7m)	175m	88m
Human beings (1.7m)	425m	213m
Vehicle(5m)	1250m	625m

Note: According to the Johnson criteria, the measurement distance of thermal imagers is still uncertain. It will be affected by objective factors such as the target and the atmospheric environment when detecting.

7. USB Communication

After connecting the USB cable to the computer, users can view and delete pictures taken by the thermal imager on the computer.

8. Charging

This device supports 5V/1A or 5V/2A power adapters for charging. Please use power adapters with safety certification.

9. Safety Instructions

- Do not aim the lens of the thermal imager at a strong light source such as the sun or laser for a long time; otherwise the thermal imager will be damaged.
- Clean the housing with a damp cloth or soap liquid. Do not use abrasives, isopropyl alcohol or solvents to clean the device housing lens/window.
- Do not direct the laser at eyes.
- The product must be stored in a dry environment without corrosive gas, away from direct sunlight.
- Do not violently disassemble the product to avoid irreversible damage.

10. Packing List

After opening the packing box, please check carefully whether the following items are missing or damaged:

1. Thermal monocular----- 1PCS
2. User manual----- 1PCS
3. USB cable----- 1PCS

* Contents of this manual are subject to change without prior notice.*

UNI-T®

UNI-TREND TECHNOLOGY (CHINA) CO., LTD.

No.6, Gong Ye Bei 1st Road,
Songshan Lake National High-Tech Industrial
Development Zone, Dongguan City,
Guangdong Province, China

彩盒 菲林做货要求

序号	项目	内容	备注
1	尺寸	110*150mm	
2	材质	128双铜+80g双铜	
3	颜色	四色	
4	外观要求	完整清晰、版面整洁，无斑墨、残损、毛边、刀线错位等缺陷。	
5	装订方式	骑马钉	
6	表面处理		
7	其它	无	
版本		REV. 0	
DWH 设计	宣浩	MODEL 机型: UtX318	Part NO. 物料编号: 110401111060X
CHK 审核		 优利德科技(中国)有限公司 UNI-TREND TECHNOLOGY (CHINA) LIMITED	
APPRO. 批准			