



**ERGO BACKPACK VACUUM  
OWNER'S MANUAL**

**Model: VACBP1**

**120V 12A, 1400W ETL US Canada**

## **IMPORTANT SAFETY INSTRUCTIONS**

When using an electrical appliance, basic precautions should always be followed, including the following:

### **READ ALL INSTRUCTIONS BEFORE USING APPLIANCE**

#### **WARNING:**

#### **TO REDUCE THE RISK OF FIRE, ELECTRICAL SHOCK OR INJURY:**

1. Do not leave appliance when plugged in. Unplug from outlet when not in use and before servicing.
2. Electrical shock may occur if used outdoors or on wet surfaces.
3. Do not allow to be used as a toy. Close attention is necessary when used by or near children.
4. Use only as described in this manual. Use only manufacturer's recommended instructions.
5. Do not use with damaged cord or plug. If appliance is not working as it should, has been dropped, damaged, left outdoors, or dropped into water, return it to Atrix International.
6. Do not pull or carry by cord, use cord as a handle, close a door on cord, or pull cord around sharp edges of corners. Do not run appliance over cord. Keep cord away from heated surfaces.
7. Do not unplug by pulling on cord. To unplug, grasp plug, not the cord.
8. Do not handle plug or appliance with wet hands.
9. Do not put any object into openings. Do not use with any opening blocked; keep free of dust, lint, hair, and anything that may reduce airflow.
10. Keep hair, loose clothing, fingers and all body parts away from openings and moving parts.
11. Do not pick up anything that is burning or smoking such as cigarettes, matches or hot ashes.
12. Do not use without filter in place.
13. Turn off all controls before unplugging.
14. Use extra care when cleaning on stairs.
15. Do not use to pick up any liquids, including flammable or combustible liquids such as gasoline or use in areas where they may be present.
16. Connect to a properly grounded outlet only.
17. This appliance is not intended for use by persons (including children) with reduced physical, sensory or mental capabilities, or lack of experience and knowledge, unless they have been given supervision or instruction concerning use of the appliance by a person responsible for their safety. Children should be supervised to ensure that they do not play with the appliance.

**SAVE THESE INSTRUCTIONS!**



1. Main Unit
2. Exhaust Grill
3. On/Off Power Switch
4. Canister Lid Tabs
5. Waist Band
6. Shoulder Straps
7. Back Board Panel
8. Carry Handle
9. Hose Inlet
10. Canister Lid
11. Flexible Hose
12. Flexible Hose handle
13. Variable Suction Control
14. Telescopic Tube
15. Telescopic Tube Button
16. Waist Band Back Support Panel
17. Waist Band
18. Oval Dusting Brush
19. Crevice Tool
20. Blowing Port
21. Furniture Nozzle
22. Floor to Carpet Brush
23. Exhaust Filter
24. Blowing Attachments
25. HEPA Dust Bag
26. Shake-Out Bag
27. HEPA Pre-Motor Filter
28. Turbo Brush (Not Pictured)

## OPERATING INSTRUCTIONS

**Warning:** To reduce the risk of electric shock, the power cord must be disconnected before removing the dust bag, shake-out bag, changing the filters or performing maintenance or trouble-shooting checks.

### **Assembling Your Vacuum**

**Cleaner - Note:** Always remove the power plug from the wall outlet before attaching or removing accessories.

**Important:** Do NOT use the vacuum without all filters, shake-out bag, and HEPA dust bag in place.

- 1 Unplug the power cord and remove the flexible hose.
- 2 To open the canister lid, press on the canister lid tabs on each side of the unit and lift canister lid.



(Fig. 1)

- 3 Pull the tab on the HEPA dust bag holder out slightly and flip upwards. (Fig. 2)



(Fig. 2)

- 4 Holding the HEPA dust bag in your hand, slide it firmly between the slots in the bag holder. (Fig. 2)
- 5 The cardboard face to the new bag should rest securely in the dust bag cover guidelines. (Fig. 3)



(Fig. 3)

- 6 Ensure that the shake-out bag is in place. (Fig. 4)

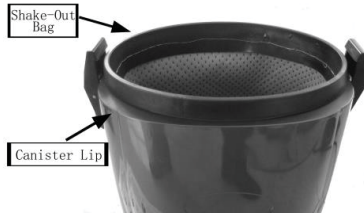

(Fig. 4)

- 7 Flip the HEPA bag holder over, pressing the tab on the bag holder until it clicks, then replace the canister lid.

- 8 The canister lid can be replaced on the unit with the hose opening on the right or left, as per your preference. (Fig. 5)

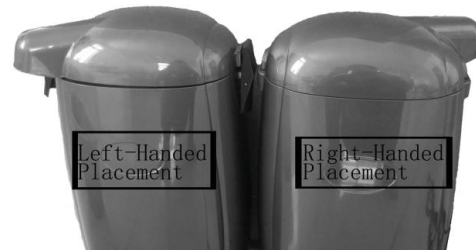

(Fig. 5)

### Attaching the Flexible Hose to the Vacuum

The flexible hose should be connected to the vacuum before strapping the unit to your back.

- 1 To connect the flexible hose into the hose inlet, insert the threaded end of the flexible hose into the hose inlet and turn counter-clockwise until it locks into place. (Fig. 6)



(Fig. 6)

- 2 Plug the power cord into the electrical outlet.
- 3 To remove the flexible hose, unplug the power cord and then turn the hose clockwise and pull the flexible hose out.

### Attaching the Telescopic Tube to the Flexible Hose Handle

- 1 Holding the telescopic tube, insert the handle into the telescopic tube receptacle. Push the handle in. (Fig. 7)

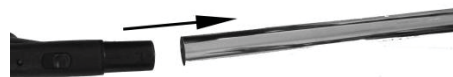

(Fig. 7)

- 2 Push forward on the plastic button and pull the inner tube outward to extend for a longer reach. (Fig. 8)

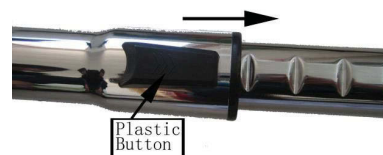

(Fig. 8)

- 3 To remove the telescopic tube from the flexible hose, pull on the telescopic tube and flexible hose handle to pull it out.

**Note:** Always remove the power plug from the wall outlet before attaching or removing accessories.

**Warning:** To reduce the risk of electric shock, the power cord must be disconnected before removing the dust bag, shake-out bag, changing the filters or performing maintenance or trouble-shooting checks.

## **Manual Suction Control**

Your vacuum cleaner includes a manual variable suction control on the flexible hose handle. The suction power can be adjusted by moving the suction regulator to the desired position between open and closed. (Fig. 10)

Open gives you less suction, closed maximum suction. For example, less suction is required on upholstery and draperies compared to thick carpets, which require maximum suction.



(Fig. 10)

## **Using the Floor to Carpet Brush**

**1** To attach the floor to carpet brush to the telescopic tube, insert the telescopic tube into the carpet to floor brush. (Fig. 11)



(Fig. 11)

**2** Step on the floor to carpet selector to adjust the height if the brushes. There are two different heights one for floors and one for carpets.

(Fig. 12)



(Fig. 12)

**3** To remove the telescopic tube from the floor to carpet brush, pull the telescopic tube out from the floor to carpet brush.

**3** To remove the telescopic tube from the floor to carpet brush, pull the telescopic tube out from the floor to carpet brush.

## **Using the Attachments**

### **Oval Dusting Brush**

The dusting brush is used for furniture.



### **Crevice Tool**

Use for radiators, crevices, corners, baseboards and between cushions.



### **Furniture Nozzle**

This utensil is used for furniture and rugs.



## **Air Driven Turbo Brush**

The efficiency of your air driven turbo brush depends on the bristle brush rotating at high speed. Strong air suction is needed to accomplish this. In order to ensure that maximum air suction is maintained, please read the following instructions:

- 1** Change the HEPA dust bag or empty the shake-out bag frequently.
- 2** Replace the pre-motor and exhaust filters as needed.
- 3** Ensure that the rotating brush is kept free of hair and string, which may accumulate and decrease brush performance.
- 4** To attach the air driven turbo brush, insert the telescopic tube into the air driven turbo brush.
- 5** To adjust the suction control on the air driven turbo brush slide the suction control for more or less as desired.

**Warning:** To reduce the risk of electric shock, the power cord must be disconnected before removing the dust bag, shake-out bag, changing the filters or performing maintenance or trouble-shooting checks.



## **Blower Attachments**

The blower attachments can be used with the vacuum to pick



up very fine dirt particles in tight crevices or spots, or to inflate inflatable items or air mattresses. The blower attachments have air bleed holes. These air bleed holes help relieve some air pressure so that the attachment does not blow off. However, should an increase in air pressure be desired, simply cover one or more of the air bleed holes.

To use the blower attachments:

- 1** Pull up and hold the exhaust tab, with the free hand pull out the exhaust grill. (Fig. 13)

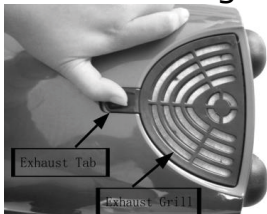

(Fig. 13)

- 2** Remove the exhaust filter.
- 3** To place the power port into the exhaust outlet, align the lower tabs on the blower port with the slots on the exhaust. Pull up on the exhaust tab and push the top of the blower port until it snaps into place. (Fig. 14)

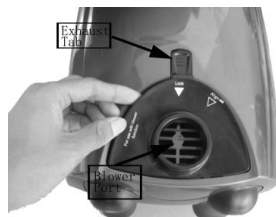

(Fig. 14)

- 4** To attach the hose to the blower port, align the flexible hose and turn counter-clockwise until it stops. The hose is now securely in place. (Fig. 15)



(Fig. 15)

- 5** To blow up inflatable items, select the appropriate size blower attachment that will fit into the air valve. (Fig. 16)



(Fig. 16)

- 6** Turn the unit on and hold the blower attachment and air valve while the vacuum exhaust is pumping air into the inflatable.
- 7** To detach the flexible hose turn clockwise and pull out from blower port.

**Note:** Firmly hold the flexible hose by the attachment when blowing dirt or dust off of objects.

## **Using the Blower Attachments**

The blower attachments are extremely useful for vacuuming in hard to reach crevices and small compartments such as in cars.

**Important Note:** When blocking the air holes. Grasp the blower attachment firmly so that they do not blow off.

Do not use blower function to clear dust of fragile or delicate objects unless they are secured or held firmly in place as the blower action is quite strong and may cause damage.

## **Using Your Vacuum**

- 1** Insert the power plug into the extension cord, then plug the extension cord into the wall outlet.
- 2** Connect hose and telescopic tube if desired.
- 3** Correctly place shoulder straps on each shoulder and secure the waist strap.

**Warning:** To reduce the risk of electric shock, the power cord must be disconnected before removing the dust bag, shake-out bag, changing the filters or performing maintenance or trouble-shooting checks.

- 4 Turn the unit on by pressing the switch located near the base of the unit to turn the vacuum cleaner on. (Fig. 17)

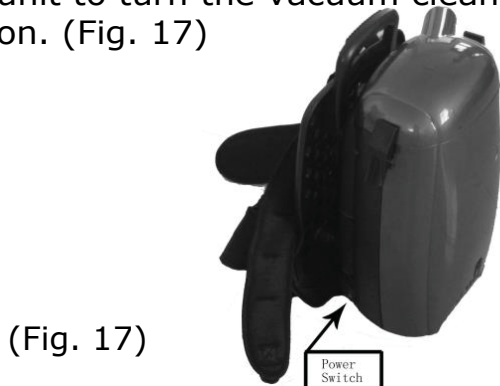

### **Removing & Replacing HEPA Dust Bag**

**Important:** **DO NOT** use the vacuum without all filters, shake-out bag, and with or without HEPA dust bag in place.

To remove the HEPA dust bag from the vacuum:

- 1 To remove the HEPA dust bag, press on the canister lid tabs on each side of the unit and lift canister lid. (Fig. 18)



- 2 Pull the tab on the HEPA dust bag holder out slightly and flip upwards.
- 3 Hold the HEPA dust bag in your hand, slide it out from the slots in the bag holder. Hold carefully in order to avoid having dust fall out of the HEPA dust bag. (Fig. 19)

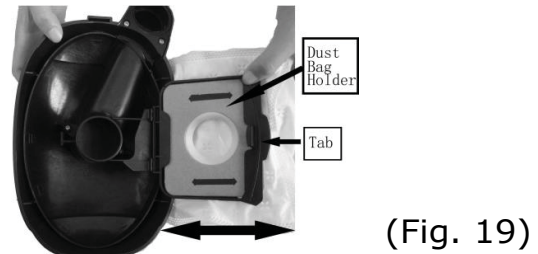

- 4 Replace the HEPA dust bag with a new bag. **Do not** reuse the same bag.
- 5 The cardboard face of the new bag should rest securely in the dust bag cover guides. (Fig. 20)

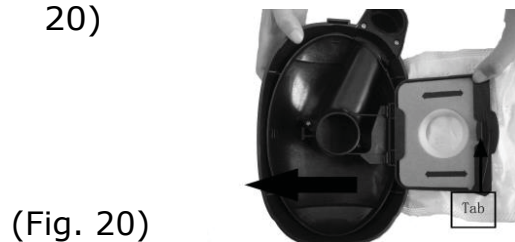

**Cleaning & Replacing the Shake-Out Bag - Note:** Clean the shake-out bag outdoors when changing the HEPA dust bag. Optimum performance is achieved by using the HEPA dust bag with the shakeout bag decreasing the need for washing the shake-out bag.

### **Cleaning & Replacing when used with the HEPA Dust Bag:**

- 1 Replace the shake-out bag, holding the handle at the bottom of the bag, shake outdoors vigorously over a garbage receptacle until there is no more dust.
- 2 Inspect shake-out bag regularly for tears or damage. Replace shake-out bags if damage or tears are present.



### **Cleaning the Shake-Out Bag:**

- 1** Remove the shake-out bag, shake vigorously outdoors or over your trash bin until there is no more dust.
- 2** The shake-out bag is hand washable in lukewarm water.
- 3** Allow to air dry for **24 hours**. The shake-out bag should be replaced when needed. **Never replace into the vacuum if still wet**
- 4** Replace clean shake-out bag in unit, and replace the canister lid onto the vacuum.

### **Cleaning the HEPA Pre-Motor Filter**

#### **Important – Please Note:**

The HEPA pre-motor filter will stop most of the tiniest dust particles and airborne allergens from re-entering the air you breathe. In fact, it stops 99.97% of all particles as small as 0.3 microns – many times smaller than a human hair! Because of this incredible filtration performance, the HEPA pre-motor filter will accumulate many fine dust particles that are difficult to see. Be assured that the HEPA pre-motor filter is doing the job. Clean or replace the HEPA pre-motor filter from time to time, when it is visibly dirty or if you notice reduced suction, as described in this section.

- 1** Remove the shake-out bag from the canister. The **HEPA** pre-motor filter is located underneath the shake-out bag. Pull up near the tabs on the sides of the HEPA filter. This is a press fit system.
- 2** Vigorously “Tap Clean” the HEPA pre-motor filter on a hard surface to remove any residual dust that might still be on the HEPA pre-motor filter.
- 3** You can wash the HEPA pre-motor filter by running it under the tap and allowing the water to run on the dirty side at least once a month or when suction appears to be decreased.

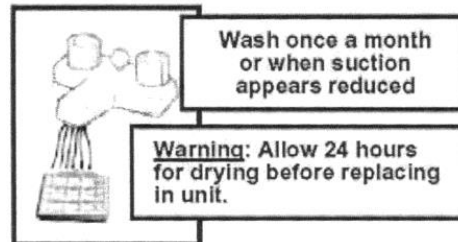

**Warning: To reduce the risk of electric shock, the power cord must be disconnected before removing the dust bag, shake-out bag, changing the filters or performing maintenance or trouble-shooting checks.**

## **How to properly use the cord relief:**



**Step 1:** Connect backpack cord to extension cord.  
\*Extension cord not included with VACBP1



**Step 2:** Create a loop with the extension cord



**Step 3:** Place loop through cord relief



**Step 4:** Pull cord tight around the hook

**Warning:** To reduce the risk of electric shock, the power cord must be disconnected before removing the dust bag, shake-out bag, changing the filters or performing maintenance or trouble-shooting checks.

# Ergo Backpack Schematic

Product SKU: VACBP1

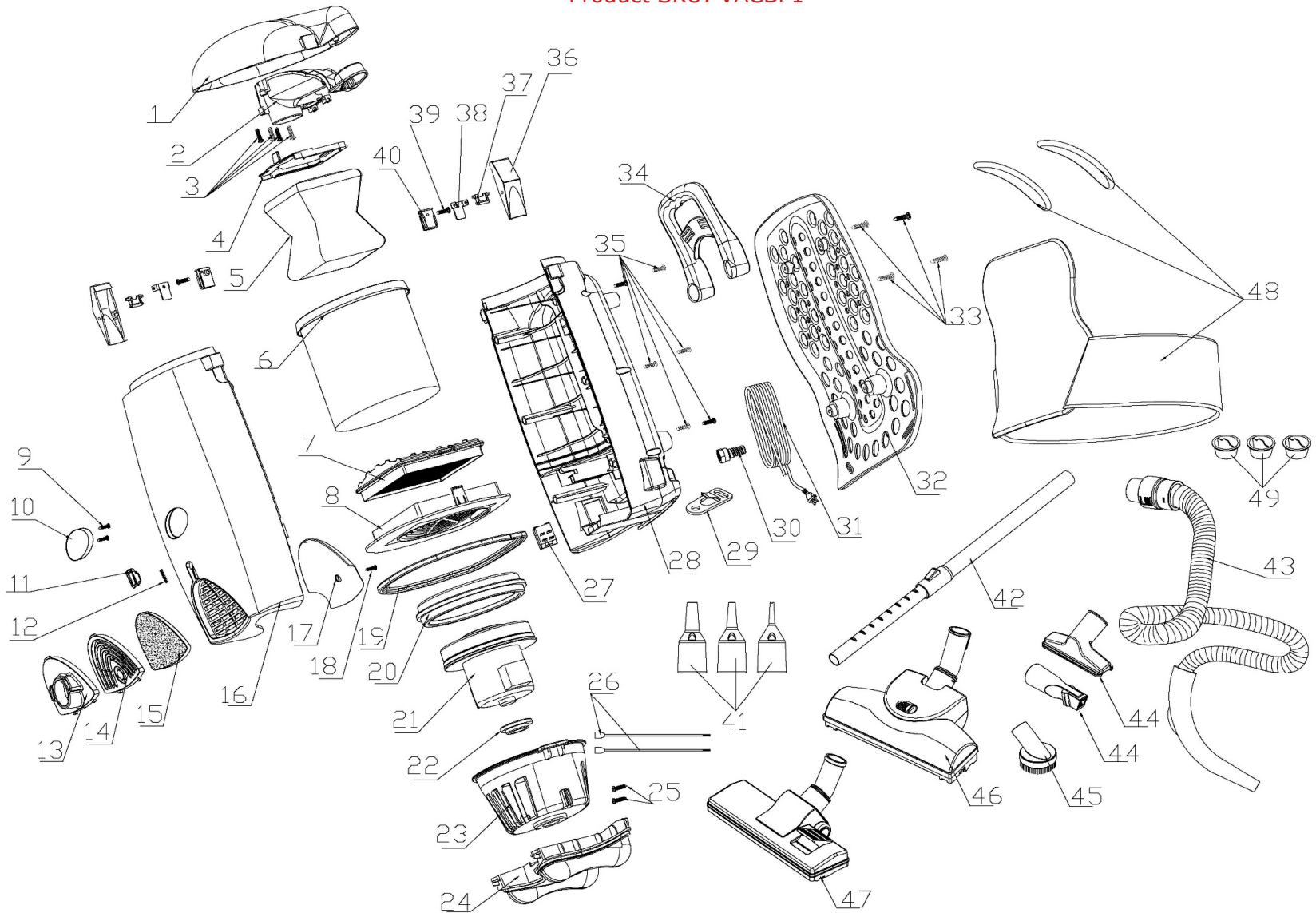

---

## **Atrix ERGO Backpack Vacuum WARRANTY INFORMATION**

**Warranty/Service Information: For warranty service information, please contact Atrix or your local Atrix distributor.**

Atrix ERGO Backpack Vacuum Limited Warranty: To the original user purchasing the Atrix ERGO Backpack Vacuum, Atrix warrants that the vacuum will be free of defects in material and manufacture for a period of one (1) year from the date of purchase. Should any failure to conform to this warranty appear within this period, Atrix will, at its option, repair or replace the defective product. It is the user's responsibility to return the product, freight prepaid, to Atrix International. These remedies are the user's exclusive remedies for breach of this warranty.

**Exclusions to warranty coverage:** The above warranty will not apply to any special configurations or to any unit that have been modified, or damaged by negligence, misuse, accident or failure to follow Atrix's Instruction manual. Consumable supplies, such as filters, accessories, and motor brushes are not covered by this warranty.

**Disclaimer of Warranty:** EXCEPT FOR THE IMPLIED WARRANTIES OF TITLE AND AGAINST PATENT INFRINGEMENT, ATRIX MAKES NO OTHER WARRANTIES WITH RESPECT TO THE ATRIX BACKPACK VACUUM CLEANER, EXPRESS OR IMPLIED, INCLUDING BUT NOT LIMITED TO ANY IMPLIED WARRANTY OF MERCHANTABILITY OR FITNESS FOR A PARTICULAR PURPOSE.

**Limitation of Liability:** ATRIX WILL NOT BE LIABLE UNDER ANY CIRCUMSTANCES FOR ANY COINCIDENTAL, SPECIAL, OR CONSEQUENTIAL DAMAGES OR ECONOMICAL LOSS, BASED UPON BREACH OF WARRANTY, BREACH OF CONTRACT, NEGLIGENCE, STRICT LIABILITY IN TORT OR ANY OTHER LEGAL THEORY, EVEN IF ATRIX HAS BEEN ADVISED OF THE POSSIBILITY OF SUCH DAMAGES INCLUDING, BUT NOT LIMITED TO LOSS OF PROFITS, REVENUE, EQUIPMENT USE, DATA OR INFORMATION OF ANY KIND. THE LIABILITY OF ATRIX SHALL NOT UNDER ANY CIRCUMSTANCE, EXCEPT AS EXPRESSLY PROVIDED HEREIN, EXCEED THE PRICE OF THE ATRIX BACKPACK VACUUM.

**To Register your Warranty Visit:**  
[www.atrix.com](http://www.atrix.com)