

**Test Equipment
Depot**

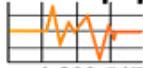

1-800-517-8431

5 Commonwealth Ave
Woburn, MA 01801
Phone 781-665-1400 Toll
Free 1-800-517-8431



Visit us at www.TestEquipmentDepot.com



Valor™ 1000 Series Instruction Manual

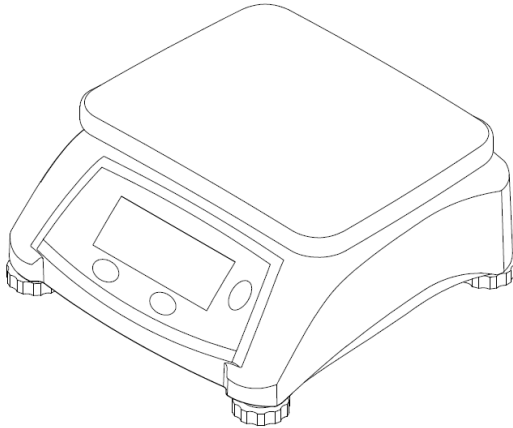

Table of Contents

1. INTRODUCTION	2
1.1 Safety Information.....	2
1.2 Intended Use	3
1.2 Controls	4
1.3 Display.....	4
2. INSTALLATION	5
2.1 Location	5
2.2 Power	5
2.3 Rechargeable Battery Power	5
2.4 Initial Calibration	6
3. OPERATION.....	6
3.1 Turning Scale On/Off	6
3.2 Weighing.....	6
4. SETTINGS.....	7
4.1 Calibration Menu.....	7
4.2 Setup Menu	8
5. LEGAL FOR TRADE.....	9
5.1 Settings.....	9
5.2 Verification.....	9
5.3 Sealing.....	10
6. MAINTENANCE.....	11
6.1 Cleaning	11
6.2 Troubleshooting	11
6.3 Service Information.....	12
7. TECHNICAL DATA.....	12
7.1 Specifications.....	13
7.2 Compliance.....	16

1. INTRODUCTION

This manual contains installation, operation and maintenance instructions for the Ohaus Valor™ 1000 Series Scales. Please read the manual completely before using the scale.

1.1 Safety Information

Definition of Signal Warnings and Symbols

Safety notes are marked with signal words and warning symbols. These show safety issues and warnings. Ignoring the safety notes may lead to personal injury, damage to the instrument, malfunctions and false results.

WARNING	For a hazardous situation with medium risk, possibly resulting in severe injuries or death if not avoided.
CAUTION	For a hazardous situation with low risk, resulting in damage to the device or the property or in loss of data, or minor or medium injuries if not avoided.
ATTENTION	For important information about the product. May lead to equipment damage if not avoided.
NOTE	For useful information about the product.

Warning Symbols



General hazard



Explosion hazard



Electrical shock hazard

Safety Precautions



CAUTION: Read all safety warnings before installing, making connections, or servicing this equipment. Failure to comply with these warnings could result in personal injury and/or property damage. Retain all instructions for future reference.

- Before connecting power, verify that the AC adapter's input voltage range and plug type are $\text{\textcircled{D}}$ compatible with the local AC mains power supply.
- Do not position the equipment such that it is difficult to reach the power connection.
- Make sure that the power cord does not pose a potential obstacle or tripping hazard.
- Operate the equipment only under ambient conditions specified in these instructions.
- The equipment is for indoor use only.
- Do not operate the equipment in wet, hazardous or unstable environments.
- Do not allow liquids to enter the equipment.

- Do not load the equipment above it's rated capacity.
- Do not drop loads on the platform.
- Do not place the equipment upside down on the platform.
- Use only approved accessories and peripherals.
- Disconnect the equipment from the power supply when cleaning.
- Service should only be performed by authorized personnel.



WARNING: Never work in an environment subject to explosion hazards! The housing of the instrument is not gas tight. (Explosion hazard due to spark formation, corrosion caused by the ingress of gases).



CAUTION: Battery is to be replaced only by an authorized Ohaus service dealer. Risk of explosion can occur if the rechargeable battery is replaced with the wrong type or if it is not properly connected. Dispose of the rechargeable battery according to local laws and regulations.

1.2 Intended Use

This instrument is intended for use in businesses and light industry. It shall only be used for measuring the parameters described in these operating instructions. Any other type of use and operation beyond the limits of technical specifications, without written consent from OHAUS, is considered as not intended. This instrument complies with current industry standards and the recognized safety regulations; however, it can constitute a hazard in use.

If the instrument is not used according to these operating instructions, the intended protection provided by the instrument may be impaired.

1.3 Controls

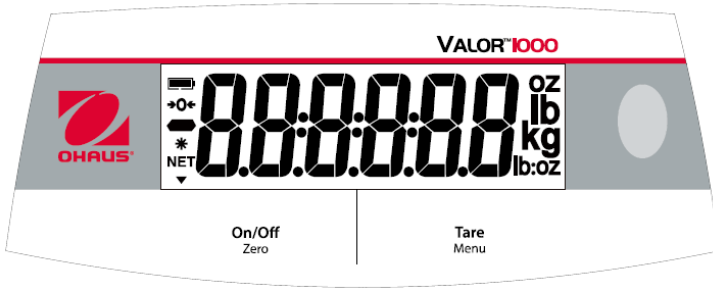

Button	Functions
<div style="border: 1px solid black; padding: 5px; text-align: center;"> On/Off Zero </div>	Press (when off): Turns the scale on Short Press (when on): Sets display to zero Long Press (when on): Turns the scale off Press (in Menu): Confirm (Enter)
<div style="border: 1px solid black; padding: 5px; text-align: center;"> Tare Menu </div>	Short Press: Enters / clears a Tare value Long Press: Enters User Menu Press (in Menu): Changes menu selections (Forward)

Notes:

Short Press: Press less than 3 seconds.

Long Press: Press and hold for more than 3 seconds.

1.4 Display

- 1 _____
- 2 _____
- 3 _____
- 4 _____
- 5 _____



Item	Description
1	Battery charge symbol
2	Center of Zero symbol
3	Negative symbol
4	Stable weight symbol
5	NET symbol

2. INSTALLATION

2.1 Location

Use the scale on a firm, steady surface. Avoid locations with excessive air current, vibrations, heat sources, or rapid temperature changes. Adjust the leveling feet so the bubble is centered in the circle.

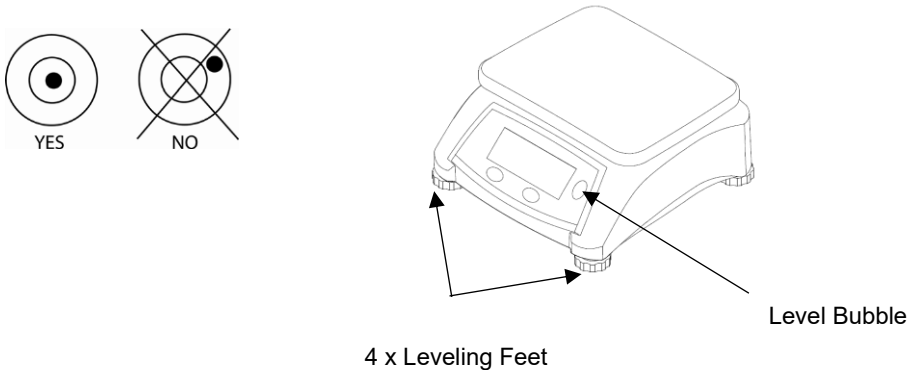

Figure 2-1. Leveling the Scale.

2.2 Power

Connect the AC Adaptor to the AC mains supply. Connect the plug to the DC jack on the bottom of the scale. The scale may be operated on the AC Adapter connected to mains supply or 4 alkaline batteries.

Note: The AC adapter maybe optional or included with the scale, depending on the region.

2.3 Rechargeable Battery Power

Allow the battery to charge for 12 hours before using the scale on battery power. The instrument can be operated during charging, and the battery is protected against overcharging. For maximum operating time, the battery should be charged at room temperature.

Note: Availability is depending on region as accessory.

WARNING: Only charge the battery when the ambient temperature is between 0 and 140 °F / 0 and 40 °C.

2.4 Initial Calibration

When the scale is operated for the first time, a Span calibration is recommended to ensure accurate weighing results. Before performing the calibration, be sure to have the appropriate calibration weight. You can also Contact an OHAUS servicing-scale dealer for more information.

Refer to section 4.1 for Span calibration procedures.

Required Span Calibration Mass (sold separately)	
Max	Mass
2000 g; 3000 g	2 kg / 6 lb
5000 g; 6000 g	5 kg / 15 lb
10000 g; 15000 g	10 kg / 30 lb
20000 g; 30000 g	20 kg / 60 lb

3. OPERATION

3.1 Turning Scale On/Off

Press **On/Off** to turn the scale on. The scale will find and set the zero weight point automatically after it displays the software version.

In weighing mode, short press **On/Off** for more than 3 seconds to turn the scale off.

3.2 Weighing

Once the scale has a stable zero weight and the tare weight of any packaging or container has been captured, place the product being weighed on the platform -- the display will show the weight of the product in the selected unit of measure.

4. SETTINGS

The scale allows the user to customize several settings including calibration, backlight operation, unit change and auto shut-off. Long press **Menu** for more than 3 seconds until you see C.R.L. . Release the **Menu** key after you enter the user menu.

4.1 Calibration Menu

Enter this menu to perform calibrations.

Once the scale displays C.R.L. , press **On/Off** to enter the Calibration Menu and perform either a Span or Linearity calibration.

For legal-for-trade use, this may have to be done in accordance with local weights and measures requirements. Contact your local servicing scale dealer for more information.

Press **Tare** to exit Calibration and to move on to the Setup Menu.

Note: Calibration is not permitted in some regions or when the scale is in Approved mode.

To unlock "Calibration", you need to enter the service menu.

Press and hold **On/Off** and **Tare/Menu** at the same time for more than 10 seconds until you see r R r r P . Release both keys to enter the service menu.

Short press **Tare/Menu** until you see L O C k . Press **On/Off** to enter the LOCK menu. Press **Tare/Menu** to change to NO.

Press **On/Off** to save the change and exit the submenu. Short press **Tare/Menu** until you see E n d . Press **On/Off** to exit the service menu.

SPAN [SPAN]

Initiates a span calibration procedure using a span calibration weight equal to the full capacity of the scale. Press **On/Off** to enter the SPAN calibration routine, or press **Tare** to proceed to a Lin calibration.

When 0.000kg is shown, short press **On/Off** to capture the zero weight if the platform is empty.

When the full capacity of the scale is shown, place a weight equal to the capacity of the scale and short press **On/Off**.

If the scale displays " C.R.L. - E ", one of the weights used to calibrate is wrong and the scale did not complete calibration.

To exit calibration at any point, short press **Tare/Menu**.

Lin [L IN]

Initiates a linearity calibration procedure (zero, mid-point and span).

When performing a linearity calibration, the scale will prompt you for a zero weight - the platform without anything on it and weight display at zero -- a Midpoint weight equal to 50% of the Span weight, and a Span weight equal to the full capacity of the scale.

When 0.000kg is shown, short press **On/Off** to capture the zero weight if the

platform is empty.

When the half capacity of the scale is shown, place a weight equal to 50% of the scale's capacity on the pan and short press **On/Off**.

When the full capacity of the scale is shown, place a weight equal to the capacity of the scale and short press **On/Off**.

If the scale displays "**CR L - E**", one of the weights used to calibrate is wrong and the scale did not complete calibration.

To exit calibration at any point, short press **Tare/Menu**.

End [**E n d**]

Press **On/Off** to advance to the Setup Menu, or press **Tare** to return to Span calibration.

Note: To exit a calibration at any time, press and hold the **On/Off** key until the scale shuts off.

4.2 Setup Menu

Enter this menu to set balance parameters.

Light:	Off, On, Auto
Unit:	kg , g, lb, oz, lb:oz
Auto shut-off:	A00 , A01, A05, A10, Off
End	Exit menu

Note: Units vary for different regions or models.

Light [**L . I . G . H . E**]

This sets the operation of the display's backlight.

ON = always on

OFF = always off

AUTO = Turns on when a button is pressed or the displayed weight changes.

Alternatively, turns off the backlight when the displayed weight does not change for more than 10 seconds.

Unit [**U . N . I . T**]

The Valor 1000 allows one weighing unit to be used at a time. Units can be changed in this menu setting and will appear when you exit the menu.

Press **On/Off** to enter the Unit submenu. You will see "kg" displayed for kilograms.

Press **On/Off** to accept kilograms as the weighing unit and exit the Unit submenu, or press **Tare** to move to the next unit.

Auto Shut-off Menu [**A . - . O . F . F**]

Set the automatic shut off time for the scale.

A00 = powers off after 5 minutes of no activity with battery powered only; disabled with AC adapter powered

A01 = powers off after 1 minute of no activity

A05 = powers off after 5 minutes of no activity
A10 = powers off after 10 minutes of no activity
Off = disabled

Beeper Key [b.P.1.É.5]

ON = turns on the beeper sound when you press any key.
OFF = turns off the beeper sound when you press any key.

End Setup [É.n.d]

Press the **Tare/Menu** key to return to the **C.A.L** menu, or press the **On/Off** key to exit to normal operation.

5. LEGAL FOR TRADE

When the scale is used in trade or a legally controlled application, it must be set up, verified and sealed in accordance with local weights and measures regulations. It is the responsibility of the purchaser to ensure that all pertinent legal requirements are met. As the requirements vary by jurisdiction, the purchaser is advised to contact their local weights and measures office for instructions about putting the balance into service.

5.1 Settings

Before verification and sealing, perform the following steps:

1. Confirm that the selected unit of measure is permitted by the local weights and measures regulations.
2. Perform a calibration as explained in Section 4.1.
3. Set the position of the security switch as shown in Section 5.3.

5.2 Verification

A weights and measures official must perform the verification procedure. Contact the local weights and measures office for more information.

5.3 Sealing

A LFT switch under the sealing cover is used to secure the menu settings. When the switch is pressed, the menu settings may be viewed but not changed. This sealing cover is located at the bottom of the scale. Remove the sealing cover with a screwdriver and then press the switch when the scale is powered on. After that you will see "L F t .01" is displayed on the screen.



LFT switch cover



LFT switch

After the scale has been verified, it must be sealed by the weights and measures official to prevent undetected access to the legally controlled settings. Refer to the illustrations below for the sealing.



Wire Sealing



Paper Sealing

6. MAINTENANCE

6.1 Cleaning



WARNING: Electric Shock Hazard. Disconnect the equipment from the power supply before cleaning. Make sure that no liquid enters the interior of the instrument.



Attention: Do not use solvents, harsh chemicals, ammonia or abrasive cleaning agents.

The housing may be cleaned with a cloth dampened with a mild detergent if necessary.

6.2 Troubleshooting

The following table lists common problems and possible causes and remedies. If the problem persists, contact OHAUS or your authorized dealer.

TABLE 5-1. TROUBLESHOOTING.

Symptom	Possible Cause	Possible Solution
Err E	Calibration error: unstable environment or incorrect calibration weight	Check environment and calibration weights, and then re-calibrate.
Err 8.1	The Power On weight on the platform exceeds the zero range.	Clear pan.
Err 8.2	The Power On weight on the platform is below the zero range.	Check if pan is missing.
Err 8.3	Over load (weight exceeds rated capacity)	Remove weight from pan.
Err 8.4	Under load (pan removed)	Re-install pan.
Err 8.5	Tare weight out of range	Tare value exceeds maximum.
Err 9.5	Internal data error or calibration data error	Contact OHAUS or your authorized dealer for help.
Err 13	Failure to write to EEPROM	Contact OHAUS or your authorized dealer for help.
Lo.bAt	Battery very low	Replace batteries; Charge rechargeable battery.
--nD--	Action not allowed	/
-----	Busy	/

6.3 Service Information

If the troubleshooting section does not resolve or describe your problem, contact your authorized OHAUS service agent. For service assistance or technical support in the United States call toll-free 1-800-672-7722 ext. 7852 between 8:00 AM and 5:00 PM EST. An OHAUS product service specialist will be available to provide assistance Monday through Friday. Outside the United States, Canada and Puerto Rico, please visit our web site, www.ohaus.com to locate the OHAUS office nearest you.

7. TECHNICAL DATA

Equipment Ratings:

Indoor use only

Altitude: 2000m

Operating temperature: 0 to 40°C

Humidity: Maximum relative humidity 80% for temperatures up to 31 °C decreasing linearly to 50% relative humidity at 40°C.

Electrical supply: 12VDC, 0.5A. For use with certified or approved power supply, which must have a SELV and limited energy circuit output.

Voltage fluctuations: Mains supply voltage fluctuations up to $\pm 10\%$ of the nominal voltage.

Overvoltage category (Installation category): II

Pollution degree: 2

7.1 Specifications

TABLE 7-1. Specifications

Model*	V12P3	V12P6	V12P15	V12P30
Capacity x Readability (Max x d non- approved)	6 lb x 0.001 lb 3 kg x 0.0005 kg 3,000 g x 0.5 g 96 oz x 0.02 oz 6 lb x 0.02 oz	15 lb x 0.002 lb 6 kg x 0.001 kg 6,000 g x 1 g 240 oz x 0.05 oz 15 lb x 0.05 oz	30 lb x 0.005 lb 15 kg x 0.002 kg 15,000 g x 2 g 480 oz x 0.1 oz 30 lb x 0.1 oz	60 lb x 0.01 lb 30 kg x 0.005 kg 30,000 g x 5 g 960 oz x 0.2 oz 60 lb x 0.2 oz
Maximum Displayed Resolution	1:6,000	1:6,000	1:7,500	1:6,000
Weighing Units	g, kg, lb, oz, lb:oz			
Application Mode	Weighing			
Tare Range	To capacity by subtraction			
Stabilization Time	≤2 seconds			
Power requirements**	4 x D cell Alkaline battery, AC adapter or rechargeable battery			
Calibration	Digital with external weight			
Typical Battery Life	1500 hours with backlight turned off			
Construction	ABS plastic housing, stainless steel pan			
Safe Overload	150% of capacity			
Specified Temperature Range	32 to 104° F / 0 to 40 °C			
Display Type	Single display, LCD with white backlight			
Display Size	1.0 in / 25.4 mm			
Pan Size	9.65 x 7.48 in / 245 x 190 mm			
Scale Dimensions (W x D x H)	10.2 x 10.6 x 4.8 in / 260 x 270 x 122 mm			
Shipping Dimensions (W x D x H)	12.6 x 12.6 x 6.9 in / 319 x 319 x 175 mm			
Net Weight	5.5 lb / 2.5 kg			
Shipping Weight	6.8 lb / 3.1 kg			

* Certain regions are available with V12PRx models, which are standard with AC adapter and rechargeable battery.

**Availability is dependent on region.

TABLE 7-2. Specifications



Model	V12P2T	V12P5T	V12P10T	V12P20T
Capacity × Readability (Max × d non- approved)	5 lb x 0.0005 lb 2 kg x 0.0002 kg 2,000 g x 0.2 g 80 oz x 0.01 oz	10 lb x 0.001 lb 5 kg x 0.0005 kg 5,000 g x 0.5 g 160 oz x 0.02 oz	20 lb x 0.002 lb 10 kg x 0.001 kg 10,000 g x 1 g 320 oz x 0.05 oz	50 lb x 0.005 lb 20 kg x 0.002 kg 20,000 g x 2 g 800 oz x 0.1 oz
Maximum Displayed Resolution	1:10,000	1:10,000	1:10,000	1:10,000
Certified Capacity × Readability (Max × e approved)	5 lb x 0.002 lb 2 kg x 0.001 kg 2,000 g x 1 g 80 oz x 0.05 oz	10 lb x 0.005 lb 5 kg x 0.002 kg 5,000 g x 2 g 160 oz x 0.1 oz	20 lb x 0.01 lb 10 kg x 0.005 kg 10,000 g x 5 g 320 oz x 0.2 oz	50 lb x 0.02 lb 20 kg x 0.01 kg 20,000 g x 10 g 800 oz x 0.5 oz
Approved Resolution	1:2,000	1:2,500	1:2,000	1:2,000
Class	Class III NTEP / Measurement Canada			
Weighing Units	g, kg, lb, oz			
Application Mode	Weighing			
Tare Range	To capacity by subtraction			
Stabilization Time	≤2 seconds			
Power requirements	4 x Alkaline battery (not included) or AC adapter (included)			
Calibration	Digital with external weight			
Typical Battery Life	750 hours without backlight			
Construction	ABS plastic housing, stainless steel pan, in-use cover			
Safe Overload	150% of capacity			
Communication	Optional RS232			
Specified Temperature Range	32 to 104° F / 0 to 40 °C			
Display Type	LCD (front and back of scale) with white backlight			
Display Size	1.0 in / 25.4mm			
Pan Size	9.65 x 7.48 in / 245 x 190 mm			
Scale Dimensions (W x D x H)	10.2 x 10.6 x 4.8 in / 260 x 270 x 122 mm			
Shipping Dimensions (W x D x H)	12.6 x 12.6 x 6.9 in / 319 x 319 x 175 mm			
Net Weight	5.5 lb / 2.5 kg			
Shipping Weight	6.8 lb / 3.1kg			

TABLE 7-3. Specification

Model	V12P3T	V12P6T	V12P15T	V12P30T
Capacity × Readability (Max × d non- approved)	3 kg x 0.0002 kg 3000 g x 0.2 g	6 kg x 0.0005 kg 6000 g x 0.5 g	15 kg x 0.001 kg 15000 g x 1 g	30 kg x 0.002 kg 30000 g x 2 g
Maximum Displayed Resolution (d)	1:15,000	1:12,000	1:15,000	1:15,000
Model	V12P3T-M	V12P6T-M	V12P15T-M	V12P30T-M
Capacity × Readability (Max × e approved)	3 kg x 0.001kg 3000 g x 1 g	6 kg x 0.002 kg 6000 g x 2 g	15 kg x 0.005 kg 15000 g x 5 g	30 kg x 0.01 kg 30000 g x 10 g
Approved Resolution	1:3,000	1:3,000	1:3,000	1:3,000
Weighing Units	g, kg			
Application Mode	Weighing			
Tare Range	To capacity by subtraction			
Stabilization Time	≤2 seconds			
Power requirements	4 x Alkaline battery (included), AC adapter (optional) or rechargeable battery (optional)			
Calibration	Digital with external weight			
Typical Battery Life	750 hours without backlight			
Construction	ABS plastic housing, stainless steel pan			
Safe Overload	150% of capacity			
Communication	Optional RS232			
Specified Temperature Range	0 to 40 °C			
Display Type	LCD (front and back of scale) with white backlight			
Display Size	25.4mm			
Pan Size	245 x 190 mm			
Scale Dimensions (W x D x H)	260 x 270 x 122 mm			
Shipping Dimensions (W x D x H)	319 x319 x175 mm			
Net Weight	2.5 kg			
Shipping Weight	3.1 kg			

7.2 Compliance

Compliance to the following standards is indicated by the corresponding mark on the product.

Mark	Standard
	This product complies with the applicable harmonized standards of EU Directives 2011/65/EU (RoHS), 2014/30/EU (EMC), 2014/35/EU (LVD) and 2014/31/EU (NAWI). The EU Declaration of Conformity is available online at www.ohaus.com/ce .
	This product complies with the EU Directive 2012/19/EU (WEEE) and 2006/66/EC (Batteries). Please dispose of this product in accordance with local regulations at the collecting point specified for electrical and electronic equipment. For disposal instructions in Europe, refer to www.ohaus.com/weee .
	EN 61326-1

Important notice for V12P...-M verified weighing instruments in the EU

When the instrument is used in trade or a legally controlled application, it must be set up, verified and sealed in accordance with local weights and measures regulations. It is the responsibility of the purchaser to ensure that all pertinent legal requirements are met.

Weighing Instruments verified at the place of manufacture bear the following supplementary metrology marking on the descriptive plate.

  1259

Weighing Instruments to be verified in two stages have no supplementary metrology marking on the descriptive plate. The second stage of conformity assessment must be carried out by the applicable weights and measures authorities.

If national regulations limit the validity period of the verification, the user of the weighing instrument must strictly observe the re-verification period and inform the weights and measures authorities.

As verification requirements vary by jurisdiction, the purchaser should contact their local weights and measures office if they are not familiar with the requirements.

ISED Canada Compliance Statement:

This Class B digital apparatus complies with Canadian ICES-003.

ISO 9001 Registration

The management system governing the production of this product is ISO 9001 certified.

FCC Supplier Declaration of Conformity

Unintentional Radiator per 47CFR Part B
Trade Name: OHAUS CORPORATION
Mo

FCC Compliance Statement:

Note: This equipment has been tested and found to comply with the limits for a Class B digital device, pursuant to part 15 of the FCC Rules. These limits are designed to provide reasonable protection against harmful interference in a residential installation. This equipment generates, uses and can radiate radio frequency energy and, if not installed and used in accordance with the instructions, may cause harmful interference to radio communications. However, there is no guarantee that interference will not occur in a particular installation. If this equipment does cause harmful interference to radio or television reception, which can be determined by turning the equipment off and on, the user is encouraged to try to correct the interference by one or more of the following measures:

- Reorient or relocate the receiving antenna.
- Increase the separation between the equipment and receiver.
- Connect the equipment into an outlet on a circuit different from that to which the receiver is connected.
- Consult the dealer or an experienced radio/TV technician for help.

Changes or modifications not expressly approved by the party responsible for compliance could void the user's authority to operate the equipment.

LIMITED WARRANTY

OHAUS products are warranted against defects in materials and workmanship from the date of delivery through the duration of the warranty period. During the warranty period OHAUS will repair, or, at its option, replace any component(s) that proves to be defective at no charge, provided that the product is returned, freight prepaid, to OHAUS.

This warranty does not apply if the product has been damaged by accident or misuse, exposed to radioactive or corrosive materials, has foreign material penetrating to the inside of the product, or as a result of service or modification by other than OHAUS. In lieu of a properly returned warranty registration card, the warranty period shall begin on the date of shipment to the authorized dealer. No other express or implied warranty is given by OHAUS Corporation. OHAUS Corporation shall not be liable for any consequential damages.

As warranty legislation differs from state to state and country to country, please contact OHAUS or your local OHAUS dealer for further details.