

Functions:

(1) On/off

(1) Press "on/off" button to switch on.

A beep sound occurs indicating the unit is switched on.

LCD display shows all functions for a seconds and then turn to normal mode.

In normal mode, the display shows reading of:

- (i) pressure: in the unit of mb (mbar) (or inHg).
- (ii) height: shows in the unit of m (meter) (or ft).
- (iii) temperature: shows in the unit of °C (or °F).
- (iv) direction: shows in whole circle bearing, e.g. 255° (or compass bearing e.g. S75°W (=255°).
- (v) time: shows and starts time at 12 hour format e.g. 12:00am (or 24 hour format).
- (vi) calendar: shows in d/m with day (or m/d).
- (vii) bar graph
- (viii) weather forecast: show in graphic icon

To operate under the scope of the above (i) to (viii), press "mode" to switch as following:

- (i) "BARO", "ALT", "TEMP", "DIR", "TIME" and "CAL"
- (ii) "BARO", "ALT", "TEMP", "TIME" and "CAL"

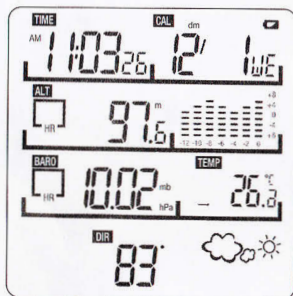

(A) ~ (G): "Function" Display

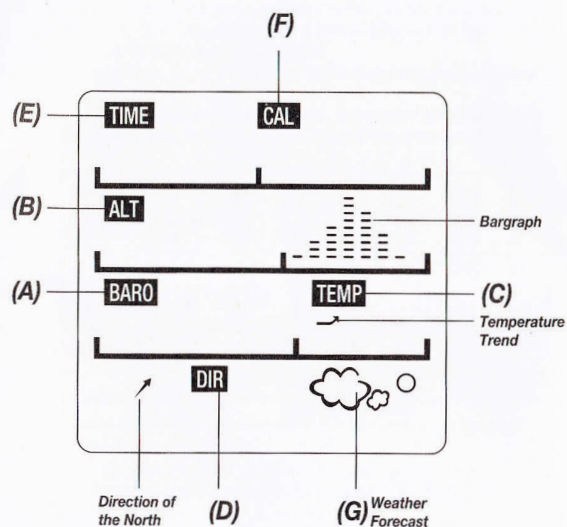

- (i) Go to (2a)
- (ii) Press and hold "set", "OFF" displays, which representing the reference altitude is not in use.
- (iii) Press "+" or "-" to turn on the reference altitude setting and "On" display.
- (iv) Press "set" to confirm, real time altitude flashing.
- (v) Press "+" once to increase one digit or press and hold "+" to for acceleration of increments.
- (vi) Press "-" once to decrease one digit or press and hold "-" for acceleration of increments.
- (vii) Press "set" to confirm and real time altitude change to the preset reference altitude.
- (viii) If no reference altitude is set and turn off, the unit uses the preset value for altitude calculation.

(5) Switch on/off altitude measurement

In order to save battery life, user can switch off the measurement of altitude.

- (i) Go to (2a), Press "set" and "-" to switch off the measurement of altitude.
- (ii) Display reads "----" It stops the measurement of altitude.
- (iii) When the measurement is stopped, the unit keeps updating the altitude for every 15 minutes (same as the pressure measurement).
- (iv) Press "set" and "-" together in (2a) to switch on the measurement again. Display reads real time reading immediately and update every second immediately.
- (v) Should the measurement is switched off, the unit will still convert the altitude by the pressure value in every 15 minutes and bar graph will also be updated accordingly.
- (vi) Should the measurement is switched off, other value in (2a) to (2g) will keep as last reading.

(6) Altitude max/min memory recalling

- (i) Go to (2b), display shows the maximum reading.
- (ii) Press "+" to show maximum altitude tested. "MAX" shows on the display.
- (iii) To clear the memory, in (6ii), press and hold "set" the reading reset the memory to 0 (a beep sound) and start to record the maximum reading.
- (iv) Press "-" to show minimum altitude tested. "MIN" shows on the display.
- (v) To clear the memory, in (6iv), press and hold "set" the reading reset the memory to 0 (a beep sound) and start to record the maximum reading.
- (vi) Press "+" and "-" together to (2c).



(7) Altitude Trend (past 12 hours reading)

- (i) Go to (2c), Display will show one altimeter reading for the previous past hour with "- 1hr" next to the reading.
- (ii) Press "+" or "-" to check record of reading in other hours within the past 12 hours.

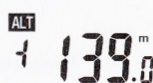

(8) High/low altimeter alarm

- (i) Go to (2d), display shows flashes "AL".
- (ii) Press and hold "+" to set and check high alarm, "AL" and "HI" flashes. -700m or previous reading shows on the display; or
- (iii) Press and hold "-" to set and check low alarm, "AL" and "LOW" flashes. -700m or previous reading shows on the display.
- (iv) To set the alarm, Press "+" or "-" to set the desired alarm setting. -700m → 9000m → -700m, each press 10th, continue press 100th.
- (v) Press and hold "set" to confirm and the display returns to (2a) real time reading and shows "HI" or "LOW"
- (vi) When the reading reaches the alarm setting, alarm beep turns on for 15 times. "HI" or "LOW" flashing.



Measurement and Display function

(A) Pressure

To look for BARO information:

(1) Press "mode" to pressure mode.

BARO appears, Bar graph for the pressure trend of previous 12 hours shows.

Press "mode" again to exit and switch to the "ALT" mode.

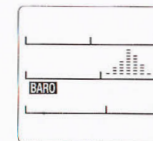

(2) BARO mode includes following functions:

- (a) Real-time pressure reading in mb (hPa) or inHg.
- (b) Pressure trend reading (past 12 hours readings)

To switch between (a) and (b), press "+" and "-" together

(3) Air pressure unit switchable

- (i) Go to (2a)
- (ii) Press together "set" and "+" to switch between mb (hPa) and inHg.



(4) Pressure Trend (past 12 hours reading)

- (i) Go to (2b). Display will show one pressure reading for the previous past hour with "- 1hr" next to the reading.
- (ii) Press "+" or "-" to check record of reading in other hours within the past 12 hours.

- (vii) Press any key to stop the alarm and "HI" or "LOW" stops flashing; or it stops automatically after 15 times.
- (viii) To delete high alarm setting, press "set" and "+" in (2d) to delete high alarm set, "HI" disappear;
- (ix) To delete low alarm setting, press "set" and "-" in (2d) to delete low alarm set, "LOW" disappear.
- (x) Press "+" and "-" to exit and switch to (2e).

(9) Current ascent/descent rate

- (i) Go to (2e), display shows the current ascent rate. "▲" shows on the display.
- (ii) Press "-" to show current descent rate. "▼" shows on the display.
- (iii) Press "+" and "-" together to return to (2f).



(10) Ascent/descent differential altitude

- (i) Go to (2f), display shows the ascent differential altitude reading. "▲H" and "▲" shows on the display.
- (ii) Press "+" to show ascent differential altitude reading. "▲H" and "▲" shows on the display.
- (iii) To clear the memory, in (10ii), press and hold "set", the reading reset to 0 and start to record the ascent differential altitude reading.
- (iv) Press "-" to show descent differential altitude reading. "▲H" and "▼" shows on the display.
- (v) To clear the memory, in (10iv), press and hold "set" the reading reset to 0 and start to record the descent differential altitude reading.
- (vi) Press "+" and "-" together to switch (2g).

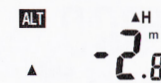

(11) Accumulative ascent/descent altitude

- (i) Go to (2g), display shows the accumulative ascent altitude reading. "Σ" and "▲" shows on the display.
- (ii) Press "+" to show accumulative ascent altitude tested. "Σ" and "▲" shows on the display.

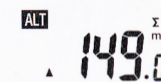

(B) Altitude

To look for ALT information:

(1) Press "mode" to altimeter mode.

ALT appears, Bar graph for the altimeter trend of previous 12 hours shows.

Press "mode" again to exit and switch to the "TEMP" mode.

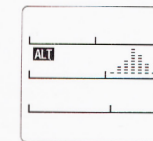

(2) ALT mode includes following functions:

- (a) Real time altimeter reading in m or ft
- (b) Max/min altimeter memory recalling
- (c) Altimeter Trend (past 12 hours reading)
- (d) High/low altimeter alarm
- (e) Current ascent/descent rate in ft/hr or m/hr
- (f) Ascent/descent differential altitude ▲, ▲H; ▼, ▼H
- (g) Accumulative ascent/descent altitude Σ+, ▲ or Σ+, ▼

To switch between (a) and (g), press "+" and "-" together

(3) Altitude unit switchable

- (i) Go to (2a).
- (ii) Press together "set" and "+" to switch between m or ft.



(4) Setting a reference altitude

The altimeter uses the pressure sensor to detect the current air pressure, which is then used to estimate the current altitude. The unit is pre-programmed with preset values, which are used to convert air pressure reading to altitude values. If a reference altitude is used, the unit will calculate relative altitude based on the reference altitude (not the preset value).

After a reference altitude is set, the unit adjusts the air-pressure-to-altitude conversion calculation accordingly. The altitude measurements calculated is subjected to error caused by the change in air pressure. Therefore updating the reference altitude whenever one is recommended.

- (iii) To clear the memory, in (11ii), press and hold "set" the reading reset to 0 and start to record the accumulative ascent altitude tested.
- (iv) Press "-" to show accumulative descent altitude tested. "Σ" and "▼" shows on the display.
- (v) To Clear the memory, in (11iv), press and hold "set" the reading reset to 0 and start to record the maximum reading.
- (vi) Press "+" and "-" together to return to (2a)

(C) Temperature

To look for TEMP information:

(1) Press "mode" to TEMP mode.

TEMP appears.

Press "mode" again to exit and switch to "DIR" (or "TIME") mode.

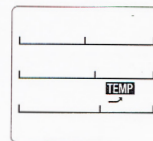

(2) TEMP mode includes following functions:

- (a) Real-time temperature reading; and
- (b) Temperature trend (An arrow shows on the display representing the temperature is)
 - (i) rising; or ↗
 - (ii) steady; or →
 - (iii) down going ↘

(3) °C/°F switchable

- (i) Go to (2a)
- (ii) Press together "set" and "+" to switch between °C and °F.

(4) Temperature max/min memory recalling

- (i) Go to (2a)
- (ii) Press "+" to show maximum temperature tested. "MAX" shows on the display.
- (iii) Press "-" to show minimum temperature tested. "MIN" shows on the display.
- (iv) Press and hold "set" to clear memory. Individually, Display returns to real time in 5 secs.



(D) Direction

To look for Compass information:

- (1) Press "mode" to DIR mode.
 - (a) Real time direction reading in whole circle bearing or compass bearing
 - (b) Calibration function
- (2) DIR mode includes following functions:
 - (a) Real time clock
 - (b) Alarm time setting (▲ shows on the display)
 - (c) Timer (count up and count down); ∇ shows on the display
- (3) Type of bearing switchable
 - (i) Press "set" and "+" to switch between different types of bearing.
- (4) Calibration
 - (i) In "DIR" mode, Press and hold "set". "CAL" appears.
 - (ii) Turn the unit for 360 degree horizontally.
 - (iii) Press and hold "set" to confirm and exit to real-time compass.
- (5) Sleep mode
 - (i) When the unit is in the compass mode, it starts to measure and update the direction every second for 1 minute.
 - (ii) Afterward the display read "---".
 - (iii) In compass mode, press "set" to reactivate the unit to measure and update the direction every second for 1 minute; or
 - (iv) Press "mode" to exit and re-enter to the DIR mode again.



(E) Time

To look for TIME information:

- (1) Press "mode" to time mode.
 - (a) Real time clock
 - (b) Alarm time setting (▲ shows on the display)
 - (c) Timer (count up and count down); ∇ shows on the display
- (2) TIME mode includes following function:
 - (a) Real time clock
 - (b) Alarm time setting (▲ shows on the display)
 - (c) Timer (count up and count down); ∇ shows on the display
- (3) 12/24switchable
 - (i) Go to (2a),
 - (ii) Press together the "set" and "+" to switch between 12/24 time format.
- (4) Clock Set
 - (i) Go to (2a), press and hold "set". Hour digits flash.
 - (ii) Press "+" or "-" to set hour digits. Press "set" to confirm. Minute digits flash.
 - (iii) Press "+" or "-" to set minute digits. Press and hold "set" to confirm and go back to real time mode. Second digits return to 00.
- (5) Alarm and snooze On/Off
 - (i) Go to (2b), press and hold "set" to get into the alarm mode, Hour digits flash.
 - (ii) Press "+" or "-" to set hour digits. Press "set" to confirm. Minute digits flash.

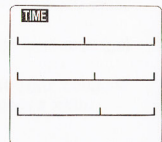

- (iii) Press "+" or "-" to set minute digits. Press and hold "set" to confirm.
 - (iv) When time is reached, ▲ flashes and beeping sound of alarm will last for 1 minute. Press any key to stop the alarm.
 - (v) To get into the alarm with snooze mode, press "set" again, both ▲ & Z' flashes.
 - (vi) When time is reached, ▲ flashed and stop it by pressing any key. While Z' start flashing. Snooze will sound for every 5 minutes and repeat for 5 times.
 - (vii) Press "set" to cancel both function mode ▲ & Z'.
 - (viii) Press "+" and "-" to return to the real time mode.
- (6) Timer Set (23:59:59)
 - Go to (2c), "∇" flashes. Time digits "0:00:00" show on the display.
 - (7) Count up
 - (i) Press "mode" to start count up.
 - (ii) Press "mode" to pause/stop and re-start.
 - (iii) May press together "+" and "-" to go to other time mode during counting while the "∇" flashes during counting.
 - (8) Count down
 - (i) Press and hold "set". Hour digits flash. Press "+" or "-" to set hour digit. Press "set" to confirm. Minute digits flash.
 - (ii) Press "+" or "-" to set minute. Press "set" to confirm. Second digits flash.
 - (iii) Press "+" or "-" to set second. Press "set" to confirm.
 - (iv) When setting is confirmed, all digit stop flashing and all are set well.



- (v) When all digits are set well. Press "mode" to start count down.
 - (vi) Press "mode" to pause and re-start.
 - (vii) During counting, may press together "+" and "-" to go to other time function and "∇" flashes during count down.
 - (viii) When time is reached, it sounds for 1 minute and digit remain "0:00:00". Or press any key to stop beeping when time is reached.
 - (ix) Press "mode", the last setting will display. Simply press "mode" again to start count down again.
- (9) Timer clear
 - (i) In timer "∇" mode, press "mode" to pause counting. Then press "set" to clear. Timer digits return to "0:00:00"

(F) Calendar

To look for CALENDAR information:

- (1) Press "mode" to CAL mode.
 - "CAL" will appear.
- (2) CAL mode includes :
 - (a) date and month showing (d/m or m/d) with day
 - (b) year showing (2000-2059)
- (3) Switchable d/m or m/d
 - (i) Go to (2a), press together "set" and "+" to switch between "d/m" or "m/d".

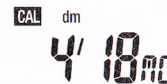
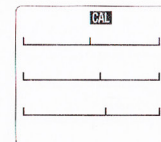

©2011 Control Company. 92-4198-00 Rev. 1 062011

HAND HELD DIGITAL BAROMETER

- (4) Language for Day and Calendar set
 - (i) Go to (2a), "d/m" or "m/d" shows.
 - (ii) Press and hold "set", display shows "E" representing English for day showing.
 - (iii) Press "+" or "-" to select the language. Display show as following: "E" → "D" → "F" → "I" → "S" → "E"



You can select E for English, D for German, F for French, I for Italian or S for Spanish. They are shown in the language chart below.

Language	Day-of-the-week						
	Mon	Tues	Wed	Thur	Fri	Sat	Sun
English	E	Mo	Tu	We	Th	Fr	Sa Su
German	D	Mo	Di	Mi	Do	Fr	Sa So
French	F	Lu	Ma	Me	Je	Ve	Sa Di
Italian	I	Lu	Ma	Me	Gi	Ve	Sa Do
Spanish	S	Lu	Ma	Mi	Ju	Vi	Sa Do

- (iv) Press "set" to confirm and month digits flash first. Press "+" or "-" to set month. Press "set" to confirm. Then date digits flash.
- (v) Press "+" or "-" to set date. Press and hold "set" to confirm and go back to real time mode.
- (vi) Go to (2b). "yr" shows and 4 places digit shows also.
- (vii) Press and hold "set", the last 2 digits of year flash (the first 2 digits "20" will not flash). Press "+" or "-" to set year from "00" to "59".
- (viii) Press and hold "set" to confirm and go back to real time mode.

(G) Weather forecast

To look for Weather forecast

(It will be shown on the display by all time. Includes icons of the following)

- (i) sunny ☀
- (ii) partly cloudy ☁ ☀
- (iii) cloudy ☁
- (iv) rainy ☁ ☔
- (v) thunder storm ☁ ⚡
- (vi) moon and star ✨ * ○

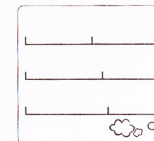

Backlight

- (i) Press "B/L" to turn on the backlight.
- (ii) Press again to switch off. Or it will turn off automatically after 10 seconds.

Battery Replacement

Turn the Main Unit over. Use a coin or similar opener to open cover. Insert a new batteries (2 x 3 volts "CR2032" size or equivalent) as the direction indicated. Close the cover.

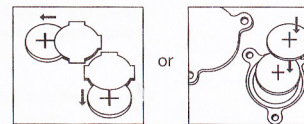

Maintenance/ Precautions

- Do not leave the Main Unit exposed to direct sunlight when the unit is not in use.
- Do not disassemble the Main Unit and sensor.
- Check relative position of sensor periodically.
- For cleaning, use neutral detergent on soft cloth, and wipe off later with dry cloth. Do not apply paint thinner, benzine, or alcohol, to avoid damages on the surface.
- If there is mud, sand or clog-like between the button and the body, the movement of the button may be disturbed. Softly wash away such objects with water.

Specification

Air Pressure
 Pressure Range: 300 ~ 1100mb (hPa); 8.85inHg ~ 32.45inHg
 Resolution: 1 mb/hPa; 0.01inHg
 Sensing Time: 15 minutes

Altitude
 Altitude Range: -700m ~ +9000m; -2296ft ~ +29520ft
 Resolution: 0.1m for -500.0m to 999.9m; otherwise 1m
 Sensing time: 2 sec
 (Sensing time under sleep mode is 15 minutes)

Temperature
 Temperature range: -10°C ~ +60°C or +14°F ~ +140°F
 Resolution: 0.1°C or 0.1°F
 Sensing Time: 1 min

Direction
 Range: 0-359°
 Resolution: 1°
 Sensing time: 1 sec for 1 min
 Unit: whole circle bearing, e.g. 255°
 (or compass bearing e.g. S75W (=255))

Test Equipment Depot
 1-800-517-8431

5 Commonwealth Ave
 Woburn, MA 01801
 Phone 781-665-1400
 Toll Free 1-800-517-8431